

 **VANGUARD**



2023 PHOTO VIDEO

ABOUT VANGUARD

Vanguard is a global company that designs and manufactures tripods, bags, sporting optics, and accessories. For over 30 years, our drive to disrupt mediocrity and our commitment to innovation has allowed us to create the highest quality products for photographers and outdoor enthusiasts at an affordable price.

Growing into a global leader since its founding in 1986, VANGUARD provides more than our competitors because we are the factory. There are no third-party factories, development or design firms, or other outsourcing of any kind in the process.

Every step of the process is orchestrated by Vanguard's in-house R & D, production, administration, marketing and sales teams in Vanguard-owned and controlled facilities. This enables us to ensure standout product quality, hear customers directly, support the professionals and to provide excellent after sales service. Vanguard is truly a global brand with distribution, sales, marketing and administrative branches in the U.S., Luxembourg, Spain, Germany, United Kingdom, Japan, and China. From these locations, Vanguard team members collaborate closely to ensure a consistent, efficient global operation.

Every day, hundreds of thousands of photographers rely on Vanguard tripods, monopods, ball heads, bags and cases. Tens of thousands of outdoor enthusiasts appreciate Vanguard's premium binoculars, spotting scopes and related goods that bring them closer to nature.



CONTENTS

ABOUT VANGUARD	-----	2
NEW PRODUCTS	-----	4
FACTORY	-----	6
KEY FEATURES	-----	7

TRIPODS/MONOPODS/HEADS PAGE

ALTA PRO 3VRL VIDEO TRIPOD	-----	10
ALTA PRO 3VL VIDEO TRIPOD	-----	12
VEO 3V VIDEO TRIPOD	-----	14
VEO 3+ MAGC TRIPOD	-----	16
VEO 3T+ MAGC TRAVEL TRIPOD	-----	18
VEO 3 AB/CB TRADITIONAL TRIPOD	-----	20
VEO 3 APS/CPS TRADITIONAL TRIPOD	-----	21
VEO 3 AD/CO TRADITIONAL TRIPOD	-----	22
VESTA TRADITIONAL TRIPOD	-----	23
VEO 3T TRADITIONAL TRAVEL TRIPOD	-----	24
VEO 3 GO TRADITIONAL TRAVEL TRIPOD	-----	26
VESTA TB TRADITIONAL TRAVEL TRIPOD	-----	28
VEO 3TT TABLE TRIPOD	-----	30
VESTA TTI TABLE TRIPOD	-----	32
VEO 2S MONOPODS	-----	33
VEO BH/VEO BP HEADS	-----	34
VEO PH/VEO PV HEADS	-----	35
VEO MT-12	-----	36
VEO CSM/VEO TC/VEO TSA	-----	37
VEO SPH	-----	38
VEO CP/VEO CP KIT	-----	39
VEO QS-360/VEO LVL-60/VEO BT-II	-----	40
QUICK SHOES	-----	41

BAGS/TROLLEYS/CASES PAGE

ALTA SKY BAG K PAC K	-----	44
VEO ACTIVE CLASSIC BACKPACKS	-----	48
VEO SELECT SHOULDER BAGS / MESSENGER BAG/TROLLEY BAG/CLASSIC BACKPACKS	-----	50

VEO CITY CROSS BODY BAG / TECH POUCH	-----	56
VEO RANGE T BACKPACK	-----	60
VEO RANGE SHOULDER BAGS	-----	61
VEO ADAPTOR CLASSIC BACKPACKS / SHOULDER BAGS	-----	62
VEO GO SHOULDER BAGS / BACKPACKS	-----	64
VEO BIB T PHOTOGRAPHIC BAG IN BAG	-----	65
VEO BIB F PHOTOGRAPHIC BAG IN BAG	-----	66
VEO BIB DIVIDER S PHOTOGRAPHIC BAG IN BAG	-----	67
DIVIDER BAG PHOTOGRAPHIC BAG IN BAG	-----	68
SUPREME MULTIFUNCTION HARD CASES	-----	69
VESTA ASPIRE SHOULDER BAGS / BACKPACKS	-----	70
ALTA ACCESSORIES	-----	72

SPORTING OPTICS/ACCESSORIES PAGE

ENDEAVOR HD SPOTTING SCOPES	-----	76
ENDEAVOR XF SPOTTING SCOPES	-----	77
VEO HD SPOTTING SCOPES	-----	78
VESTA SPOTTING SCOPES KITS	-----	79
VEO HD IV BINOCULARS	-----	80
VEO HD 2 BINOCULARS	-----	81
VEO HD BINOCULARS	-----	82
VEO ED BINOCULARS	-----	83
VEO XF BINOCULARS	-----	84
VESTA BINOCULARS	-----	85
VESTA COMPACT BINOCULARS	-----	86
VEO HD2 1042M MONOCULAR	-----	87
VEO ED 8420M MONOCULAR	-----	88
VESTA 8320M MONOCULAR	-----	89
OPTICS ACCESSORIES	-----	90
VEO OPTIC GUARD	-----	91

SPECIFICATIONS PAGE

ALTA PRO

ALTA PRO 3VRL AT/CT P10

3VRL



01

ALTA PRO 3VRL 303 AV/CV 20 P10

(NEW HEAD)
VEO PV-20 P35



02

ALTA PRO 3VRL 303 AV/CV 18 P10

(NEW HEAD)
VEO PV-18 P35



03

ALTA PRO

ALTA PRO 3VL 303 AV/CV 20 P12

3VL

(NEW HEAD)
VEO PV-20 P35



04

ALTA PRO 3VL 303 AV/CV 18 P12

(NEW HEAD)
VEO PV-18 P35



05

ALTA PRO 3VL 263 AV/CV 16 P12

(NEW HEAD)
VEO PV-16



06

VEO LVL-60

1/2 BALL LEVEL P40



12

CHECK OUT WHAT'S NEW IN 2023

VANGUARD LISTENS TO THE VOICE OF CONSUMERS AND CONTINUOUSLY INVESTS IN RESEARCH AND DEVELOPMENT TO PROVIDE A GREAT EXPERIENCE

VEO XF

P84



14

VEO 3V

VEO 3V 303 AV/CV 18 P14

(NEW HEAD)
VEO PV-18 P35



07

VEO 3V 263 AV/CV 16 P14

(NEW HEAD)
VEO PV-16



08

VEO 3+

VEO 3+303ABS/CBS P16

(NEW HEAD)
VEO BH-250S P34

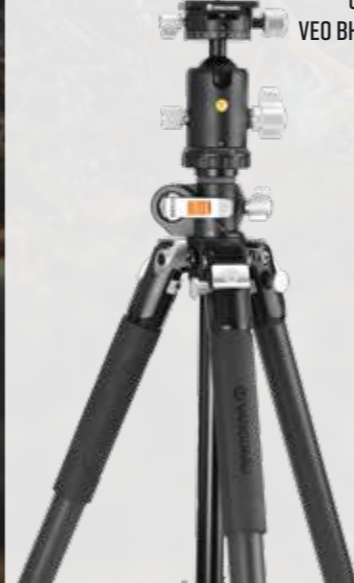

09

VEO 3

VEO 3 303AB/CB P20

(NEW HEAD)
VEO BH-250S P34



10

VEO 3 303APS/CPS P21



VEO 3TT

TABLE TRIPODS P30



11

VEO CITY CB

CROSS-BODY BAGS P56



VEO CITY TP

TECH POUCHES P58



13

FACTORY

TOTAL PRODUCT OWNERSHIP FROM IDEA TO FINISHED PRODUCT



UNMATCHED QUALITY CONTROL

Vanguard founders credit our success to the people across the globe who have given supportive and valuable feedback about product features and price points over our three decades. This focus on listening to the market's needs and wants has inspired us to create products with first-of-its-kind features, notable reliability and impressive price points. Notable industry publications and media have consistently recognized our products' quality and performance. We're privileged to have earned top honors from the Technical Image Press Association, the Red Dot Design Award, iF Design Award, the Industrial Designers Association of America, Gmark, and other respected global and local organisations

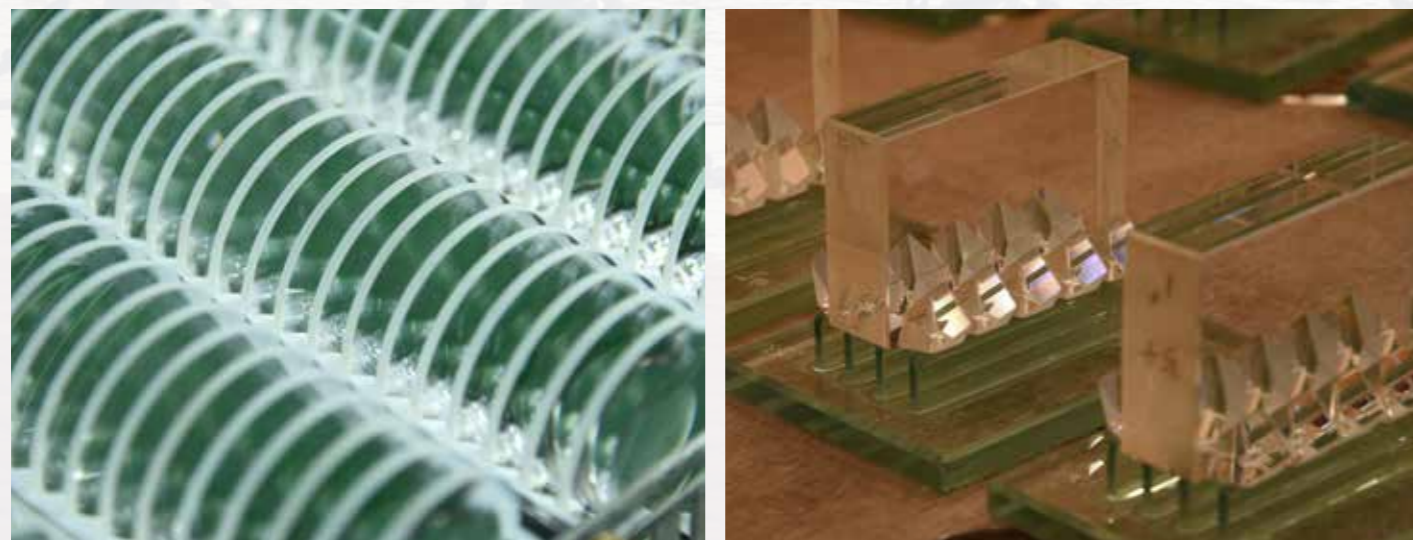

TRIPOD KEY FEATURES



EXTENDED HEIGHT
Center column and leg sections fully extended height



STANDARD HEIGHT
Center column down (not folded) and leg sections fully extended height

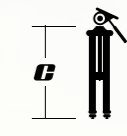

FOLDED HEIGHT
Center column and leg sections folded height



MINIMUM HEIGHT
Leg sections in lowest position with center column extended or changed to low angle adaptor

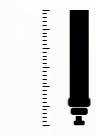

LEG DIAMETER
The diameter of 1st leg sections

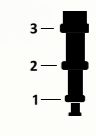

SECTIONS
Number of leg sections



HEAD
The model No. of the head



MAX LOAD
The maximum weight the tripod can support



WEIGHT
The weight of the product



MATERIAL
The product's main material



CARBON FIBER
The main material is carbon fiber



ALUMINIUM ALLOY
The main material is aluminum alloy

SPORTING OPTICS KEY FEATURES



PREMIUM HOYA ED GLASS
Setting new standards with a rating of more than 95% light transmission, HOYA ED glass launches Vanguard optical design above the competition, ensuring brightness and clarity even in the lowest light.



SK-15 PRISMS
Exceeding BAK4 prisms in image quality, SK15 minimizes undesirable internal reflections and light rays resulting in increased edge-to-edge brightness and clarity.



PREMIUM ED GLASS
Vanguard's Extra-low Dispersion (ED) glass significantly reduces chromatic aberrations, allowing clear, sharp viewing with high contrast.



MULTIGUARD® COATINGS
Vanguard's MultiGuard® coatings provide multiple layers of anti-reflective compounds resulting in optimal light transmission and producing a remarkably clear field of view.



TRIPOD MOUNTABLE
With the tripod mountable feature, you can easily mount your optics to any tripod or monopod for hands-free stable viewing



RAPID FOCUS EYEPIECE
The rapid focus eyepiece can be adjusted in seconds, giving you a clear and crisp view of your target.



WATERPROOF & FOGPROOF
Vanguard's O-ring seals completely prevent moisture, dust, and debris from entering the optics. Nitrogen purging prevents fogging in extreme weather conditions.



LOCKING DIOPTRER RING
The diopter lets users adjust the focus to accommodate differences between each of their eyes. The diopter rings lock so that adjustments don't need to be made before each use.



2 & 3 STAGE TWIST EYE CUPS
Vanguard's twist-up eye cups come in 2 or 3 stage adjustments, allowing a customized fit for a comfortable viewing experience with or without eyeglasses.



LOW LIGHT PERFORMANCE
The fully multicoated lenses improve light transmission for bright and clear images, with greater low-light performance.



Tripods, Monopods & Heads



Since 1986, VANGUARD has been a part of the worldwide photo/video market and launched new products every year. We have been recognized by well-known awards all over the world, have worked with creators from all walks of life, and have sold our products in more than 80 countries. Vanguard's tripod/monopod/head lineup consists of three main families: **The Alta series**, which boasts advanced features geared toward professionals; **the VEO series**, which offers versatility, reliability, and cutting-edge designs for all types of users; and **the Vesta series**, our family of practical equipment designed for newcomers or those who just need a simple solution.



VIDEO TRIPOD ALTA PRO 3VRL

Vanguard's Alta Pro series is back with a new generation of professional quality. The Alta Pro 3VRL series features a removable leveling bowl base with a comfortable hand grip on the underside for ultimate control and flexibility. A selection of Arca-compatible video pan heads gives you fluid motion and smooth panning and tilting, along with precise control with dual telescopic handles. Precision-engineered, CNC-machined parts mean that your Alta Pro tripod is built to last. Easy-twist leg locks let you quickly deploy your aluminum or carbon-fiber legs. Plus, retractable steel spikes in the feet let you adapt well on any terrain.



SERIES HIGHLIGHTS

- Without center column
- 75mm Bowl removable Bowl module
- 3/8" screw connection device
- Arca compatible video pan heads
- 3-leg angles (23°, 50°, 80°)
- Max load capacity up to 45kg/99lbs
- Extends up to 1700m/66.93 inches
- Luxury padded shoulder bag

TRIPOD HEADS



VEO PV-18/QS-61P



VEO PV-20/QS-67



VEO PV-18
Arca compatible video pan head
(15kg/33lbs load capacity)

*ALTA PRO 3VRL 303CV18



VEO PV-20
Arca compatible video pan head
(6kg/13.2lbs load capacity)

*ALTA PRO 3VRL 303AV20



ALUMINUM ALLOY - 30MM LEG DIAMETER - 3 LEG SECTIONS

MODEL	FOLDED HEIGHT [INCHES MM]	EXTENDED HEIGHT [INCHES MM]	MINIMUM HEIGHT [INCHES MM]	HEAD	MAX LOAD [LBS KG]	WEIGHT [LBS KG]
NEW ALTA PRO 3VRL 303AT	29.88 759	66.93 / 1700	7.09 / 180	-	55.1 25	5.38 2.44
NEW ALTA PRO 3VRL 303AV20	33.90 861	70.94 / 1802	11.10 / 282	VEO PV-20	13.2 6	8.00 3.63
NEW ALTA PRO 3VRL 303AV18	34.02 864	71.06 / 1805	11.22 / 285	VEO PV-18	33.1 15	7.98 3.62

CARBON FIBER - 30MM LEG DIAMETER - 3 LEG SECTIONS

MODEL	FOLDED HEIGHT [INCHES MM]	EXTENDED HEIGHT [INCHES MM]	MINIMUM HEIGHT [INCHES MM]	HEAD	MAX LOAD [LBS KG]	WEIGHT [LBS KG]
NEW ALTA PRO 3VRL 303CT	29.88 759	66.93 / 1700	7.09 / 180	-	55.1 25	4.60 2.09
NEW ALTA PRO 3VRL 303CV20	33.90 861	70.94 / 1802	11.10 / 282	VEO PV-20	13.2 6	7.21 3.27
NEW ALTA PRO 3VRL 303CV18	34.02 864	71.06 / 1805	11.22 / 285	VEO PV-18	33.1 15	7.19 3.26

VIDEO TRIPOD ALTA PRO 3VL

Vanguard's Alta Pro series is back with a new generation of professional quality. The Alta Pro 3VL series features a nonremovable leveling bowl base for ultimate control and flexibility. A selection of Arca-compatible video pan heads gives you fluid motion and smooth panning and tilting, along with precise control with dual telescopic handles. Precision-engineered, CNC-machined parts mean that your Alta Pro tripod is built to last. Easy-twist leg locks let you quickly deploy your aluminum or carbon-fiber legs. Plus, retractable steel spikes in the feet let you adapt well on any terrain.

SERIES HIGHLIGHTS

- Without center column
- 65mm Bowl cannot move from canopy
- 3/8" screw connection device
- Arca compatible video pan heads
- 3-leg angles (23°, 50°, 80°)
- Max load capacity up to 30kg/66lbs
- Extends up to 1700m/66.93 inches
- Luxury padded shoulder bag



TRIPOD HEADS



ALUMINUM ALLOY - 3 LEG SECTIONS

MODEL	FOLDED HEIGHT [INCHES MM]	EXTENDED HEIGHT [INCHES MM]	MINIMUM HEIGHT [INCHES MM]	LEG DIAMETER	HEAD	MAX LOAD [LBS KG]	WEIGHT [LBS KG]
NEW ALTA PRO 3VL 303AV20	33.54 852	70.87 1800	11.02 280	30	VEO PV-20	13.2 6	8.22 3.73
NEW ALTA PRO 3VL 303AV18	33.66 855	70.87 1800	11.22 285	30	VEO PV-18	33.1 15	8.20 3.72
NEW ALTA PRO 3VL 263AV16	32.28 820	67.13 1705	7.28 185	26	VEO PV-16	22.0 10	6.72 3.05

CARBON FIBER - 3 LEG SECTIONS

MODEL	FOLDED HEIGHT [INCHES MM]	EXTENDED HEIGHT [INCHES MM]	MINIMUM HEIGHT [INCHES MM]	LEG DIAMETER	HEAD	MAX LOAD [LBS KG]	WEIGHT [LBS KG]
NEW ALTA PRO 3VL 303CV20	33.54 852	70.87 1800	11.02 280	30	VEO PV-20	13.2 6	7.43 3.37
NEW ALTA PRO 3VL 303CV18	33.66 855	70.87 1800	11.22 285	30	VEO PV-18	33.1 15	7.41 3.36
NEW ALTA PRO 3VL 263CV16	32.28 820	67.13 1705	7.28 185	26	VEO PV-16	22.0 10	5.94 2.69

VIDEO TRIPOD VEO 3V

VEO 3V video tripods are ultra-sturdy supports for high-quality video gear. With the option for one **long handle** or two telescopic handles, the Arca-compatible VEO PV-16 and PV-18 heads offer ultimate flexibility and user-friendliness. Enjoy smooth, fluid movement to stay on your subject, and rest assured that the hearty QS-61P quick-release plate will provide a steadfast foundation for your gear. Additionally, a safety pin spring design helps prevent equipment falls when things get slippery in the field.

SERIES HIGHLIGHTS

- There is a center column for height adjustment
- Reversible 3/8" to 1/4" thread
- Converts to a monopod (except 30mm legs)
- Arca compatible video pan heads
- 3-leg angles (20°, 50°, 80°)
- Max load capacity up to 30kg/66lbs
- Extends up to 1700m/66.93 inches
- Luxury padded shoulder bag

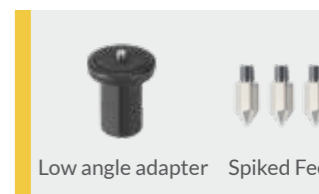

*VEO 3V 263CV16



*VEO 3V 303AV18

TRIPOD HEADS



VEO PV-16/QS-61P



VEO PV-18/QS-61P

ALUMINUM ALLOY - 3 LEG SECTIONS

MODEL	FOLDED HEIGHT [INCHES MM]	EXTENDED HEIGHT [INCHES MM]	MINIMUM HEIGHT [INCHES MM]	LEG DIAMETER	HEAD	MAX LOAD [LBS KG]	WEIGHT [LBS KG]
NEW VEO 3V 303AV18	28.94 735	71.06 1805	10.04 255	30	VEO PV-18	33.1 15	6.67 3.03
NEW VEO 3V 263AV16	28.74 730	70.47 1790	8.94 227	26	VEO PV-16	22.0 10	5.91 2.68

CARBON FIBER - 3 LEG SECTIONS

MODEL	FOLDED HEIGHT [INCHES MM]	EXTENDED HEIGHT [INCHES MM]	MINIMUM HEIGHT [INCHES MM]	LEG DIAMETER	HEAD	MAX LOAD [LBS KG]	WEIGHT [LBS KG]
NEW VEO 3V 303CV18	28.94 735	71.06 1810	10.04 255	30	VEO PV-18	33.1 15	5.96 2.71
NEW VEO 3V 263CV16	28.74 722	70.47 1810	8.94 247	26	VEO PV-16	22.0 10	5.29 2.40

MACC TRIPOD VEO 3+

VEO 3+ is an all-in-one tripod series that is sturdy and trustworthy but truly shines thanks to its outstanding versatility. The easy-to-operate Multi-Angle Central Column (MACC) can be moved 360° in any direction, making it perfect for any style of photography -- enjoy moving from macro to landscape in seconds. You can also use the MACC as a multi-mount when you pair it with the VEO+ MA1 Adaptor (provided). Attach additional equipment to the tripod to enhance any shot. Additionally, all 3+ models include a leg that converts to a monopod, a premium Arca-compatible ball or pan head (depending on model), and removable spiked feet.

SERIES HIGHLIGHTS

- Multi-Angle Central Column (MACC)
- 3-leg angles (20°, 50°, 80°)
- MACC converts to a Multi-Mount
- Max load capacity up to 25kg/55lbs
- Converts to a monopod (except 30mm legs)
- Extends up to 1774m/69.84 inches
- Arca compatible 3-way pan head or ball heads
- Luxury padded shoulder bag



Arca-compatible VEO BH-160S; **VEO BH-250S [NEW]**
Dual axis ball heads for maximum control

VEO PH-38S
Arca compatible 3-way pan head with rotating top handle



*VEO 3+ 263CPS

VEO BH-160S
Arca compatible dual axis ball head (15kg/33lbs load capacity)



*VEO 3+ 263AB160S

VEO BH-250S
Arca compatible dual axis ball head (25kg/55lbs load capacity)



*VEO 3+ 303ABS

PERFECT PARTNERS



VEO SELECT 59T (P50)



VEO TSA DLX L (P37)



VEO TCM (P37)



Up to 30mm Diam.

*VEO 3+ 303ABS



ALUMINUM ALLOY - 3 LEG SECTIONS

MODEL	FOLDED HEIGHT [INCHES MM]	EXTENDED HEIGHT [INCHES MM]	MINIMUM HEIGHT [INCHES MM]	LEG DIAMETER	HEAD	MAX LOAD [LBS KG]	WEIGHT [LBS KG]
NEW VE03+303ABS	31.14 791	69.84 1774	8.46 215	30	VEO BH-250S	55.1 25	6.47 2.94
NEW VE03+303AT	26.38 670	65.08 1653	8.46 215	30	-	44.1 20	5.05 2.29
VE03+263AB160S	30.47 774	68.46 1739	4.92 125	26	VEO BH-160S	33.1 15	5.50 2.50
VE03+263APS	30.71 780	68.31 1735	8.66 220	26	VEO PH-38S	22.0 10	5.96 2.71
VE03+263AT	26.10 663	64.09 1628	4.92 125	26	-	33.1 15	4.42 2.01

CARBON FIBER - 3 LEG SECTIONS

MODEL	FOLDED HEIGHT [INCHES MM]	EXTENDED HEIGHT [INCHES MM]	MINIMUM HEIGHT [INCHES MM]	LEG DIAMETER	HEAD	MAX LOAD [LBS KG]	WEIGHT [LBS KG]
NEW VE03+303CBS	31.14 791	69.84 1774	8.46 215	30	VEO BH-250S	55.1 25	5.70 2.59
NEW VE03+303CT	26.38 670	65.08 1653	8.46 215	30	-	44.1 20	4.29 1.95
VE03+263CB160S	30.47 774	68.46 1739	4.92 125	26	VEO BH-160S	33.1 15	4.79 2.17
VE03+263CPS	30.71 780	68.31 1735	8.66 220	26	VEO PH-38S	22.0 10	5.12 2.32
VE03+263CT	26.10 663	64.09 1628	4.92 125	26	-	33.1 15	3.71 1.68

MAGC TRAVEL TRIPOD VEO 3T+

All the same innovative features as VEO3+ but in a more compact travel size. To deliver maximum stability and a quality that is second to none in all VEO3 tripods, Vanguard uses Advanced Computer Numerical Control (CNC) Engineering Technology, backed up by high quality materials. The precise engineering available through CNC enables Vanguard to source special quality materials, such as solid blocks of aircraft grade aluminum, which are then machined into key load bearing components using a technique such as diamond cutting, with a degree of precision that can't be matched with traditional die casting techniques. These parts then receive leading edge treatments, such as Vanguard's Advanced Anodizing process, which offer the maximum protection available and extends the life of the product. This combination of innovative design, partnered with leading edge manufacturing techniques, deliver an experience that allows any photographer to explore their world with confidence.

Arca-compatible VEO BH-110S; VEO BH-160S
Dual axis ball heads for maximum control



* VEO 3T+ 264CB



*VEO 3T+ 264CB



*VEO 3T+ 264CT



SERIES HIGHLIGHTS

- Multi-Angle Central Column (MACC)
- MACC converts to a Multi-Mount
- Leg that converts to a monopod
- Arca compatible 3-way pan head or ball heads
- 3-leg angles (20°, 50°, 80°)
- Max load capacity up to 15kg/33lbs
- Folds down to 46cm/18 inches
- Luxury padded shoulder bag



VEO+MA1 Spiked Feet

VEO PH-38S
Arca compatible 3-way pan head with rotating top handle



*VEO 3T+ 264CPS

VEO BH-110S
Arca compatible dual axis ball head (10kg/22lbs load capacity)



*VEO 3T+ 234AB

PERFECT PARTNERS



VEO SELECT 58T (P50)

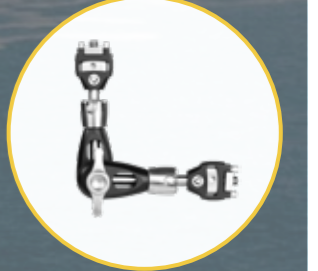

VEO TSA DLX M (P37)



VEO TCM (P37)

ALUMINUM ALLOY - 4 LEG SECTIONS

MODEL	FOLDED HEIGHT [INCHES MM]	EXTENDED HEIGHT [INCHES MM]	MINIMUM HEIGHT [INCHES MM]	LEG DIAMETER	HEAD	MAX LOAD [LBS KG]	WEIGHT [LBS KG]
VEO3T+264AB	18.9 480	61.42 1560	6.69 170	26	VEO BH-160S	33.1 15	5.41 2.45
VEO3T+234AB	18.11 460	57.48 1460	6.61 168	23	VEO BH-110S	22.0 10	4.83 2.19
VEO3T+264APS	18.9 480	61.30 1557	8.19 208	26	VEO PH-38S	22.0 10	5.84 2.65
VEO3T+234APS	18.03 458	57.48 1460	7.99 203	23	VEO PH-36S	13.2 6	5.09 2.31
VEO3T+264AT	18.9 480	57.09 1450	6.69 170	26	-	33.1 15	4.33 1.96

CARBON FIBER - 4 LEG SECTIONS

MODEL	FOLDED HEIGHT [INCHES MM]	EXTENDED HEIGHT [INCHES MM]	MINIMUM HEIGHT [INCHES MM]	LEG DIAMETER	HEAD	MAX LOAD [LBS KG]	WEIGHT [LBS KG]
VEO3T+264CB	18.9 480	61.42 1560	6.69 170	26	VEO BH-160S	33.1 15	5.01 2.27
VEO3T+234CB	18.11 460	57.48 1460	6.61 168	23	VEO BH-110S	22.0 10	4.36 1.98
VEO3T+264CPS	18.9 480	61.30 1557	8.19 208	26	VEO PH-38S	22.0 10	5.34 2.43
VEO3T+234CPS	18.03 458	57.48 1460	7.99 203	23	VEO PH-36S	13.2 6	4.66 2.12
VEO3T+264CT	18.9 480	57.09 1450	6.69 170	26	-	33.1 15	3.93 1.78

TRADITIONAL TRIPOD VEO 3 AB/CB

VEO 3 tripods are designed for every photographer who is looking for maximum stability and function in more challenging conditions. We've introduced easy-to-clean leg locks to maximize the life of the tripod with easy and efficient maintenance. One leg converts to a monopod, allowing you to pick up and plant down quickly for fast-action shots. Three adjustable leg angles offer numerous options for height and uneven terrain. Additionally, we've added a 3/8" thread to the canopy to attach a support arm. Choose from aluminum or carbon-fiber models with a dual-axis ball head.

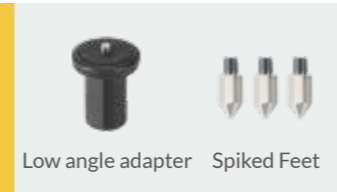

PERFECT PARTNERS



- Full sized tripods that extend to 183cm/72.1 inches
- Leg that converts to a monopod
- Arca compatible Dual axis ball head
- 3/8" thread for extra equipment to be added
- 3 easy set leg angles (20°, 50°, 80°)
- Max load capacity up to 25kg/55.1lbs

ALUMINUM ALLOY

MODEL	FOLDED HEIGHT (INCHES MM)	EXTENDED HEIGHT (INCHES MM)	MINIMUM HEIGHT (INCHES MM)	LEG DIAM.	LEG SECTIONS	HEAD	MAX LOAD (LBS KG)	WEIGHT (LBS KG)
NEW VEO3 303AB	29.3 745	72.1 1831	10.5 266	30	3	VEO BH-250S	55.1 25	5.70 2.59
VEO3 263AB	29.1 738	70.7 1795	10.4 265	26	3	VEO BH-160S	33.1 15	4.72 2.14

CARBON FIBER

MODEL	FOLDED HEIGHT (INCHES MM)	EXTENDED HEIGHT (INCHES MM)	MINIMUM HEIGHT (INCHES MM)	LEG DIAM.	LEG SECTIONS	HEAD	MAX LOAD (LBS KG)	WEIGHT (LBS KG)
NEW VEO3 303CB	29.3 745	72.1 1831	10.5 266	30	3	VEO BH-250S	55.1 25	4.93 2.24
VEO3 263CB	29.1 738	70.7 1795	10.4 265	26	3	VEO BH-160S	33.1 15	4.19 1.90



TRADITIONAL TRIPOD VEO 3 APS/CPS

VEO 3 tripods are designed for every photographer who is looking for maximum stability and function in more challenging conditions. We've introduced easy-to-clean leg locks to maximize the life of the tripod with easy and efficient maintenance. One leg converts to a monopod, allowing you to pick up and plant down quickly for fast-action shots. Three adjustable leg angles offer numerous options for height and uneven terrain. Additionally, we've added a 3/8" thread to the canopy to attach a support arm. Choose from aluminum or carbon-fiber models with two-way pan head.



PERFECT PARTNERS



- Full sized tripods that extend to 182cm/71.7 inches
- Leg that converts to a monopod
- Arca compatible 3-way pan head
- Full control of the head using telescopic handle
- 3 easy set leg angles (20°, 50°, 80°)
- Max load capacity up to 10kg/22lbs

ALUMINUM ALLOY

MODEL	FOLDED HEIGHT (INCHES MM)	EXTENDED HEIGHT (INCHES MM)	MINIMUM HEIGHT (INCHES MM)	LEG DIAM.	LEG SECTIONS	HEAD	MAX LOAD (LBS KG)	WEIGHT (LBS KG)
NEW VEO3 303APS	28.9 735	71.7 1821	10.2 259	30	3	VEO PH-38S	22.0 10	5.70 2.59
VEO3 263APS	29.1 738	70.6 1793	10.6 270	26	3	VEO PH-38S	22.0 10	5.11 2.32
VEO3 233APS	26.3 668	62.4 1585	9.5 240	23	3	VEO PH-36S	13.2 6	4.32 1.96

CARBON FIBER

MODEL	FOLDED HEIGHT (INCHES MM)	EXTENDED HEIGHT (INCHES MM)	MINIMUM HEIGHT (INCHES MM)	LEG DIAM.	LEG SECTIONS	HEAD	MAX LOAD (LBS KG)	WEIGHT (LBS KG)
NEW VEO3 303CPS	28.9 735	71.7 1821	10.2 259	30	3	VEO PH-38S	22.0 10	4.94 2.24
VEO3 263CPS	29.1 738	70.6 1793	10.6 270	26	3	VEO PH-38S	22.0 10	4.52 2.05
VEO3 233CPS	26.3 668	62.4 1585	9.5 240	23	3	VEO PH-36S	13.2 6	3.88 1.76

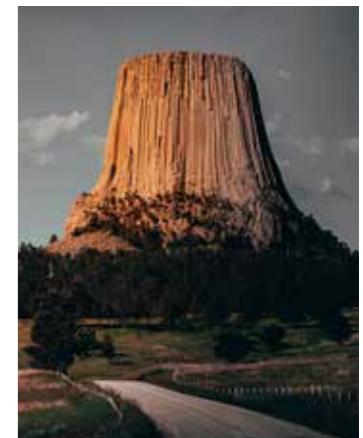

TRADITIONAL TRIPOD VEO 3 A0/CO

The VEO 3 Outdoor Series is designed to deliver a solid base for observing wildlife in the field with the most powerful spotting scopes. The series combines the solid VEO 3 tripod legs that can hold up to 100kg with the central column down, with a 2-way pan handle with all the control in a single handle. Constructed using advanced CNC engineering for maximum precision and quality, these tripods are available in a choice of carbon or aluminum.



Arca compatible VEO PH-28 2-way pan handle designed for spotting scopes



Low angle adapter Spiked Feet

PERFECT PARTNERS



VEO HD-80A (P78)



VEO PA-65 (P90)



VEO TSA DLX L (P37)

- Full sized tripods that extend to 176cm/69.4 inches
- Leg that converts to a monopod
- Arca compatible 2-way pan head
- Full control of the head using telescopic handle
- 3 easy set leg angles (20°, 50°, 80°)
- Max load capacity up to 8kg/17.6lbs

ALUMINUM ALLOY - 26MM LEG DIAMETER - 3 LEG SECTIONS

MODEL	FOLDED HEIGHT [INCHES MM]	EXTENDED HEIGHT [INCHES MM]	MINIMUM HEIGHT [INCHES MM]	HEAD	MAX LOAD [LBS KG]	WEIGHT [LBS KG]
VEO3 263AO	27.9 708	69.4 1763	9.5 240	VEO PH-28	17.6 8	5.20 2.36

CARBON FIBER - 26MM LEG DIAMETER - 3 LEG SECTIONS

MODEL	FOLDED HEIGHT [INCHES MM]	EXTENDED HEIGHT [INCHES MM]	MINIMUM HEIGHT [INCHES MM]	HEAD	MAX LOAD [LBS KG]	WEIGHT [LBS KG]
VEO3 263CO	27.9 708	69.4 1763	9.5 240	VEO PH-28	17.6 8	4.63 2.10



TRADITIONAL TRIPOD VESTA TRIPODS

VESTA tripods are a series of photo and video supports that are designed for creative image-makers or adventurous sporting optics users. Whether you are taking or partaking in the shot, this series is designed to work wherever life takes you. The VESTA Series is Vanguard's entry-level tripod offering and is designed to perform whether you are using smartphones, mirrorless/CSC/hybrid cameras, small DSLR cameras, video camcorders, or sporting optics such as binoculars and spotting scopes.



*VESTA 203AP



PH-23 (2-way pan head) Quick shoe: QS-62V3



GH-45 (Dual panning grip head) Quick shoe: QS-62V3



*VESTA 233AGH

- 3/8" to 1/4" -20 Reversible Screw Adaptor
- Converts to a monopod(except for 30mm Diam.)
- 3/8" thread for extra equipment to be added
- 20°, 50°, 80° Adjustable Leg Angles
- Choice of Aluminum & Carbon legs
- Hook to Attach Weight for Extra Stability

PERFECT PARTNERS



VESTA 460A (P79)



VEO Range T45M (P60)



VESTA ASPIRE 41 (P70)

ALUMINUM ALLOY

MODEL	FOLDED HEIGHT [INCHES MM]	EXTENDED HEIGHT [INCHES MM]	MINIMUM HEIGHT [INCHES MM]	LEG DIAMETER	LEG SECTIONS	HEAD	MAX LOAD [LBS KG]	WEIGHT [LBS KG]
VESTA 233AP	22.91 582	61.02 1550	21.69 551	23	3	PH-23	7.7 3.5	2.81 1.28
VESTA 203AP	22.50 570	61.02 1550	21.06 535	20	3	PH-23	7.7 3.5	2.44 1.11
VESTA 203AGH	22.50 570	61.02 1550	21.65 550	20	3	GH-45	7.7 3.5	2.47 1.12
VESTA 204AP	20.50 520	61.02 1550	19.41 493	20	4	PH-23	7.7 3.5	2.49 1.13



TRADITIONAL TRAVEL TRIPOD VEO 3T

The VEO 3T Series is designed to deliver both portability (with models that fold to less than 16 in/41cm and weigh 3lbs/1.4kg) and performance (with a maximum height of up to 65 in/166cm and a load capacity of up to 26.5lbs/12kg). The series also includes an innovative Arca-compatible ball head that has the option to attach a pan-handle for greater control, especially when using longer lenses or spotting scopes, and a quick release plate that can be used to attach a smartphone up to 3.35 in/85mm wide with additional accessories. As if that wasn't enough, each tripod has a leg that can convert to a monopod with an all-weather TPU grip



*VEO 3T 265 HCBP

Arca compatible VEO BP-45T ; VEO BP-50T ; VEO BP-120T
Ball head with removable handle and smartphone compatibility



*VEO 3T 265HCBP & Phone



*VEO 3T 265HCBP & Cameras



*VEO 3T 265HCBP & Spotting Scopes



QS-72T

Arca compatible quick release plate for cameras/smartphones



VEO BT-11

Bluetooth remote control for IOS and Android smartphones



SERIES HIGHLIGHTS

- Folds to 41cm/16 inches
- Weigh from just 1.4kg/3 lbs
- Max load capacity up to 12kg/26lbs
- Leg that converts to a monopod
- 3 easy set leg angles (20°, 50° & 80°)
- Arca compatible ball heads
- Include smartphone capability
- Slots for two tripod support arms



Low angle adapter Spiked Feet

VEO BP-120T (12kg/26.5lbs load capacity)



VEO BP-50T (8kg/17.6lbs load capacity)



VEO BP-45T (4kg/8.8lbs load capacity)



PERFECT PARTNERS



VEO ADAPTOR R48 (P62)



VEO TSA DLX L (P37)



VEO QS-360 (P40)

ALUMINUM ALLOY

MODEL	FOLDED HEIGHT (INCHES MM)	EXTENDED HEIGHT (INCHES MM)	MINIMUM HEIGHT (INCHES MM)	LEG DIAMETER	LEG SECTIONS	HEAD	MAX LOAD (LBS KG)	WEIGHT (LBS KG)
VEO3T265HABP	17.3 439	65.4 1660	10.0 255	26	5	VEO BP-120T	26.5 12	4.7 2.11
VEO3T235ABP	16.1 410	61.0 1550	9.4 240	23	5	VEO BP-50T	17.6 8	3.9 1.75
VEO3T204ABP	15.9 405	55.1 1400	8.9 225	20	4	VEO BP-45T	8.8 4	3.3 1.49

CARBON FIBER

MODEL	FOLDED HEIGHT (INCHES MM)	EXTENDED HEIGHT (INCHES MM)	MINIMUM HEIGHT (INCHES MM)	LEG DIAMETER	LEG SECTIONS	HEAD	MAX LOAD (LBS KG)	WEIGHT (LBS KG)
VEO3T265HCBP	17.3 439	65.4 1660	10.0 255	26	5	VEO BP-120T	26.5 12	4.2 1.91
VEO3T235CBP	16.1 410	61.0 1550	9.4 240	23	5	VEO BP-50T	17.6 8	3.5 1.60
VEO3T204CBP	15.9 405	55.1 1400	8.9 225	20	4	VEO BP-45T	8.8 4	3.0 1.38

TRADITIONAL TRAVEL TRIPOD VEO 3GO

When designing VEO 3 GO tripods, Vanguard recognized that many creators don't take a tripod along because the extra bulk and weight are cumbersome. This series is built around compact, lightweight, and travel-friendly features that let you shed your heavy load of gear and focus on your creativity. The feature-rich range is available in aluminum or extremely lightweight carbon fiber, both options ideal for all types of cameras from DSLR to mirrorless/CSC/hybrid cameras and even smart phones. The included smart phone holder and Bluetooth remote turn the VEO 3 GO into a tripod or monopod/selfie stick capable of capturing images remotely with your smartphone.



SERIES HIGHLIGHTS

- Folds to 33cm/13 inches
- Weigh from just 820g/1.8 lbs
- Max load capacity up to 10kg/22lbs
- Leg that converts to a monopod
- 3 easy set leg angles (20°, 50° & 80°)
- Arca compatible ball heads
- Include smartphone capability
- Hook to Attach Weight for Extra Stability



PERFECT PARTNERS



ALUMINUM ALLOY

MODEL	FOLDED HEIGHT [INCHES MM]	EXTENDED HEIGHT [INCHES MM]	MINIMUM HEIGHT [INCHES MM]	LEG DIAMETER	LEG SECTIONS	HEAD	MAX LOAD [LBS KG]	WEIGHT [LBS KG]
VEO 3GO 265HAB	16.14 410	65.55 1665	9.45 240	26	5	ALTA BH-102	22 10	3.66 1.66
VEO 3GO 235AB	12.99 330	53.54 1360	7.87 200	23	5	T-50	11 5	2.70 1.23
VEO 3GO 204AB	13.63 345	51.57 1310	12.99 330	20	4	T-45	6.6 3	2.08 0.95

CARBON FIBER

MODEL	FOLDED HEIGHT [INCHES MM]	EXTENDED HEIGHT [INCHES MM]	MINIMUM HEIGHT [INCHES MM]	LEG DIAMETER	LEG SECTIONS	HEAD	MAX LOAD [LBS KG]	WEIGHT [LBS KG]
VEO 3GO 265HCB	16.14 410	65.55 1665	9.45 240	26	5	ALTA BH-102	22 10	3.12 1.42
VEO 3GO 235CB	12.99 330	53.54 1360	7.87 200	23	5	T-50	11 5	2.34 1.07
VEO 3GO 204CB	13.63 345	51.57 1310	12.99 330	20	4	T-45	6.6 3	1.80 0.82

TRADITIONAL TRAVEL TRIPOD VESTA TB

VESTA TB is a cost-effective tripod with both a simple design and advanced features. The aluminum construction is lightweight, and the inverted 4- or 5-section legs fold up for compact carrying. The legs configure to 3 angles with twist-locks for quick and easy opening and closing. A two-section center column helps increase stability and height. The sturdy ball head has large ergonomic knobs, and it includes an Arca Swiss-compatible quick-release shoe (QS-64). Shoot low-angle photos by reversing the center column.



*VESTA TB 235CB

Arca compatible Ball Head T-51 | Quick shoe: QS-65
(Up to 4.5kg load capacity)



- 3/8" to 1/4" -20 Reversible Screw Adaptor
- Hidden hex wrench storage.
- Dual Center Column for increased stability

- 21°, 50°, 80° Adjustable Leg Angles
- Choice of Aluminum & Carbon legs
- Patented design with convenient accessories.

PERFECT PARTNERS



VEO PA-10



VESTA ASPIRE 41 (P70)



VEO Range 38 (P61)

ALUMINUM ALLOY

MODEL	FOLDED HEIGHT (INCHES MM)	EXTENDED HEIGHT (INCHES MM)	MINIMUM HEIGHT (INCHES MM)	LEG DIAM.	LEG SECTIONS	HEAD	MAX LOAD (LBS KG)	WEIGHT (LBS KG)
VESTA TB235AB	14.8 375	56.25 1430	10.63 270	23	5	T-51	9.9 4.5	2.65 1.20
VESTA TB204AB	14.8 375	51.18 1300	12.01 305	20	4	T-46	6.6 3	2.06 0.93

CARBON FIBER

MODEL	FOLDED HEIGHT (INCHES MM)	EXTENDED HEIGHT (INCHES MM)	MINIMUM HEIGHT (INCHES MM)	LEG DIAM.	LEG SECTIONS	HEAD	MAX LOAD (LBS KG)	WEIGHT (LBS KG)
VESTA TB235CB	14.8 375	56.25 1430	10.63 270	23	5	T-51	9.9 4.5	2.27 1.03
VESTA TB204CB	14.8 375	51.18 1300	12.01 305	20	4	T-46	6.6 3	1.77 0.80



TABLE TRIPOD VEO 3TT

The VEO 3TT Series is designed for photographers who are looking for maximum portability and functionality, where even a travel tripod is too big

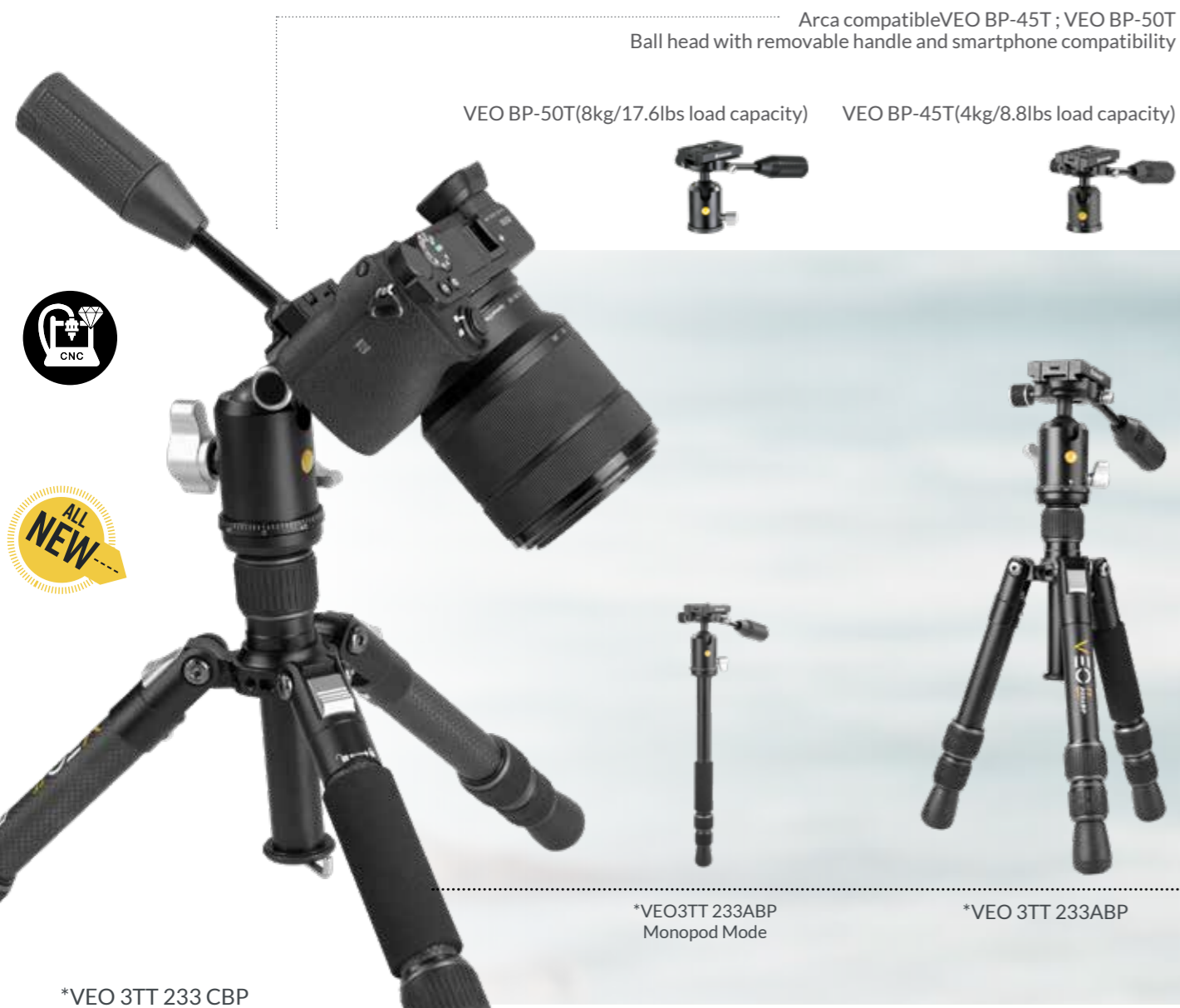

*VEO 3TT 233CBP



QS-72T

Arca compatible quick release plate for cameras/smartphones



VEO BT-11

Bluetooth remote control for IOS and Android smartphones



SERIES HIGHLIGHTS

- Folds to 41cm/16 inches
- Weigh from just 1.4kg/3 lbs
- Max load capacity up to 12kg/26lbs
- Leg that converts to a monopod
- 3 easy set leg angles (20°, 50° & 80°)
- Arca compatible ball heads
- Include smartphone capability
- Slots for two tripod support arms

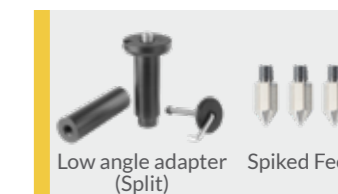

PERFECT PARTNERS



ENDEAVOR HD 65A (P76)



VEO PA-65 (P90)



VEO TSA DLX L (P37)

ALUMINUM ALLOY - 3 LEG SECTIONS

MODEL	FOLDED HEIGHT [INCHES MM]	EXTENDED HEIGHT [INCHES MM]	MINIMUM HEIGHT [INCHES MM]	LEG DIAMETER	HEAD	MAX LOAD [LBS KG]	WEIGHT [LBS KG]
NEW VEO3TT 233ABP	9.7 245	22.05 560	8.66 220	23	VEO BP-50T	17.6 8	2.56 1.16
NEW VEO3TT 203ABP	8.9 225	19.69 500	7.87 200	20	VEO BP-45T	8.8 4	2.15 0.98

CARBON FIBER - 3 LEG SECTIONS

MODEL	FOLDED HEIGHT [INCHES MM]	EXTENDED HEIGHT [INCHES MM]	MINIMUM HEIGHT [INCHES MM]	LEG DIAMETER	HEAD	MAX LOAD [LBS KG]	WEIGHT [LBS KG]
NEW VEO3TT 233CBP	9.7 245	22.05 560	8.66 220	23	VEO BP-50T	17.6 8	2.43 1.10

TABLE TRIPOD VESTA TT1

VESTA TT1 is a strong aluminum tabletop tripod that is designed to hold phones (smartphone adaptor and Bluetooth Remote included) as well as cameras up to 2 Kg. / 4.4lbs. VESTA TT has a rapid one-step leg deployment system that is unique to this category. It can be used as a stabilizer when folded, and is perfect for getting that great time-lapse or long-exposure shot! VESTA TT is compatible with a range of brands including Canon, Sony, Nikon, iPhone, and Android.



Bluetooth Remote

Smartphone Adapter up to 3.4in/8.7cm

AVAILABLE IN 4 COLOR OPTIONS

MODEL	FOLDED HEIGHT [INCHES MM]	EXTENDED HEIGHT [INCHES MM]	HEAD	MAX LOAD [LBS KG]	WEIGHT [LBS KG]
VESTA TT1	6.9 175	3.9 100	BALL HEAD	44 2	0.34 0.15



MONOPODS VEO 2S

VEO 2S is a collection of monopods designed for travel. This lightweight series works with camera loads up to 6kg/13.2lbs, and this next-gen monopod does not sacrifice quality or compromise stability. The advance-engineered twist leg locks ensure easy, fast deployment and height adjustments with no sacrifices in stability – while still allowing you to get the shot with your camera or smartphone.



Arca compatible VEO BP-50T; VEO BP-120T Ball heads for photographers and smartphonographers

VEO BT-11
Bluetooth remote control for IOS and Android smartphones

PHOTO *PRO*
★★★★★
EDITOR'S CHOICE
*VEO 2S AM-264TR

*KIT MODELS

*TR MODELS

*VEO 2S CM-264TBP120T

*VEO 2S AM-234TR

- Folds to 52cm/21 inches
- Weigh from just 800g/1.75 lbs
- Max load capacity up to 10kg/22lbs

- Arca compatible ball heads
- 4-in-1 Quick shoe QS-72T with Kit Models
- Smartphone Adapter Included with All TR Models

PERFECT PARTNERS



VEO 1042 M (P87)

VEO QS-360 (P39)

ALUMINUM ALLOY - 4 LEG SECTIONS

MODEL	FOLDED HEIGHT [INCHES MM]	EXTENDED HEIGHT [INCHES MM]	LEG DIAMETER	HEAD	MAX LOAD [LBS KG]	WEIGHT [LBS KG]
VEO2SAM-234TBP50T	23.78 604	65.12 1654	23	VEO BP-50T	13.2 6	2.81 1.28
VEO2SAM-264TR	21.50 545	64.13 1630	26	-	33.1 15	1.96 0.89
VEO2SAM-234TR	20.50 520	61.00 1550	23	-	22 10	1.77 0.81

CARBON FIBER - 4 LEG SECTIONS

MODEL	FOLDED HEIGHT [INCHES MM]	EXTENDED HEIGHT [INCHES MM]	LEG DIAMETER	HEAD	MAX LOAD [LBS KG]	WEIGHT [LBS KG]
VEO2SCM-264TBP120T	24.57 624	68.07 1729	26	VEO BP-120T	26.5 12	2.97 1.35
VEO2SCM-264TR	21.50 545	64.13 1630	26	-	33.1 15	1.75 0.80



HEAD VEO BH | DUAL AXIS BALL HEAD

Vanguard presents three of its latest, most innovative Arca-compatible ball heads: VEO BH-110S, VEO BH-160S, and VEO BH-250S. These introduce the new Dual Axis Design, which includes a second panoramic axis on the top plate for maximum control and precision when framing your shot. With a maximum load capacity of up to 25kg/55lbs on a lightweight body, easy-grip locking knobs, and a new adjustable knob mechanism, these heads deliver strong, smooth, and precise movements for the most discerning of photographers.



ARCA COMPATIBLE DUAL AXIS BALL HEADS



VEO BH-250S VEO BH-160S VEO BH-110S

VEO BH-250S

MODEL	LENGTH [INCHES MM]	WIDTH [INCHES MM]	HEIGHT [INCHES MM]	HEAD BASE [INCHES MM]	QUICK SHOE	FRONTAL TILT°	LATERAL TILT°	SWIVEL°	MAX LOAD [LBS KG]	WEIGHT [LBS KG]
NEW VEO BH-250S	-	-	4.76 121	2.28 58	QS-62V3	-	-9°-35°	360	55 25	1.42 0.64
VEO BH-160S	-	-	4.37 111	2.28 58	QS-62V3	-	-9°-35°	360	33 15	1.07 0.49
VEO BH-110S	-	-	4.13 105	1.97 50	QS-62V3	-	-9°-35°	360	22 10	0.94 0.43



HEAD VEO PH | 3-WAY PAN HEAD WITH ROTATING TOP HANDLE

The VEO PH series is perfect for any photographer or videographer on the go and features an independent panoramic knob and bubble level. Additionally, nature lovers can mount a spotting scope or binoculars (with the BA-185 adapter, sold separately) and pan smoothly to get a clear look at some birds or other wildlife.



ROTATE THE TOP HANDLE IN 90° SECTIONS INTO THE MOST COMFORTABLE POSITION FOR YOUR SHOT



VEO PH-36S

VEO PH-38S

MODEL	LENGTH [INCHES MM]	WIDTH [INCHES MM]	HEIGHT [INCHES MM]	HEAD BASE [INCHES MM]	QUICK SHOE	FRONTAL TILT°	LATERAL TILT°	SWIVEL°	MAX LOAD [LBS KG]	WEIGHT [LBS KG]
VEO PH-38S	8.27 210	7.09 180	4.41 112	2.28 58	QS-74	-9°-30°	-9°-30°	360°	22 10	1.42 0.64
VEO PH-36S	8.07 205	6.97 177	4.37 111	1.97 50	QS-74	-9°-30°	-9°-30°	360°	13.2 6	1.25 0.57

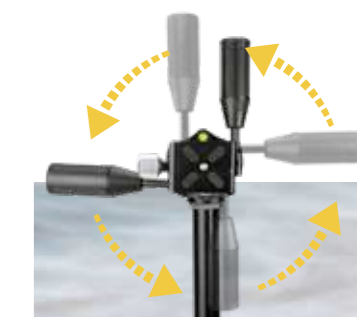

HEAD VEO BP | BALL HEAD WITH PAN HANDLE FOR CAMERAS/SMARTPHONES

Vanguard presents three innovative new Arca-compatible ball heads – VEO BP-45T, VEO BP-50T, and VEO BP-120T. These feature the quick-action removeable pan handle and the QS-72T quick shoe plate, which takes smartphone photography to a new level. With a maximum load capacity of up to 12kg/26.5lbs on a lightweight body, easy-grip locking knobs, and a new adjustable knob mechanism, these heads deliver strong, smooth, and precise movements for the most discerning of photographers.



4-IN-1 QUICK SHOE QS-72T DETACHABLE TELESCOPIC HANDLE



VEO BP-120T VEO BP-50T VEO BP-45T

VEO BP-120T

MODEL	LENGTH [INCHES MM]	WIDTH [INCHES MM]	HEIGHT [INCHES MM]	HEAD BASE [INCHES MM]	QUICK SHOE	FRONTAL TILT°	LATERAL TILT°	SWIVEL°	MAX LOAD [LBS KG]	WEIGHT [LBS KG]
VEO BP-120T	-	3.82 97	4.23 107.5	1.85 47	QS-72T	-	-9°-35°	360	26.4 12	1.2 0.55
VEO BP-50T	-	3.07 78	3.91 99	1.73 44	QS-72T	-	-9°-40°	360	17.6 8	1.0 0.46
VEO BP-45T	-	2.68 68	3.5 89	1.65 42	QS-72T	-	-9°-35°	360	8.8 4	0.87 0.39



HEAD VEO PV | FLUID VIDEO PAN HEAD

VEO PH Video head has 360-degree, smoothpanning and impressive tilting angles. It's a brilliant combination for any photographer who demands meticulous positioning for the perfect shot. Fluid video head with rigid magnesium alloy construction. Spring counterbalance helps operate heavy equipment with greater balance. Smooth pan and tilt. Long handle for greater precision and torque.



TELESCOPIC DOUBLE LONG HANDLE

VEO PV-20



VEO PV-18

VEO PV-18

MODEL	LENGTH [INCHES MM]	WIDTH [INCHES MM]	HEIGHT [INCHES MM]	HEAD BASE [INCHES MM]	QUICK SHOE	FRONTAL TILT°	LATERAL TILT°	SWIVEL°	MAX LOAD [LBS KG]	WEIGHT [LBS KG]
NEW VEO PV-20	14.37 365	5.71 145	4.02 102	2.28 58	QS-67	-60°-90°	-	360°	13.2 6	2.62 1.19
NEW VEO PV-18	15.94 405	6.02 153	4.13 105	2.28 58	QS-61P	-45°-90°	-	360°	33.1 15	2.60 1.18



TRIPOD ACCESSORY VEO MT-12

The newly designed Vanguard VEO MT-12 is the upgraded version of Vanguard's previous Multi-Mount 6. Ideal for mounting up to 4 pieces of gear, it features sturdy aluminum alloy material, is 25.6in/650mm long, has a large center locking ring, two safety pins, length adjustment bar and comes with two VEO+MA1s. Well thought out and built, If you are looking to mount multiple pieces of gear on a tripod, then look no further -- the VEO MT-12 is your ideal solution.

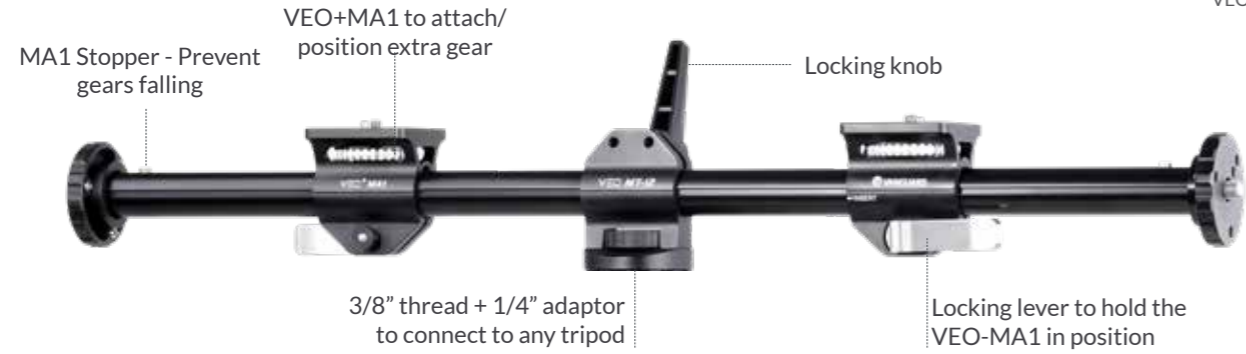

MODEL	LENGTH [INCHES MM]	WIDE [INCHES MM]	HEIGHT [INCHES MM]	FULL EXTENDED HEIGHT [INCHES MM]	WEIGHT [LBS KG]	PAYLOAD [LBS KG]	CENTER COLUMN PLATE DIAMETER [INCHES MM]	TUBE MATERIAL
VEO MT-12	-	-	-	25.6 650	2.26 10.25	22.04 10.00	2.28 58	ALUMINUM ALLOY
VEO+MA1	2.3 58	3.3 83	2.7 68	-	0.46 0.21	-	-	ALUMINUM ALLOY



ACCESSORY VEO CSM / VEO TC / VEO TSA

With the ever growing demand for flexibility, Vanguard is proud to introduce the VEO Creative Tripod Accessories Series that is designed to turn your tripod into a multi-functional tool for any photography style.



VEO CSM - Cold Shoe Mounts

A versatile range of cold shoe mounts that allow you to attach and aim up to three accessories (LED lights, microphones, etc.) to your camera and tripod.

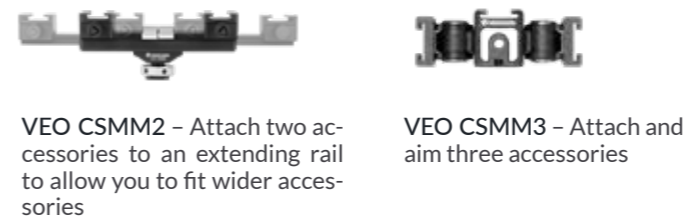

VEO TSA - Tripod Support Arms

Attach a tripod support arm to your tripod (or VEO CSM3) to add additional accessories.

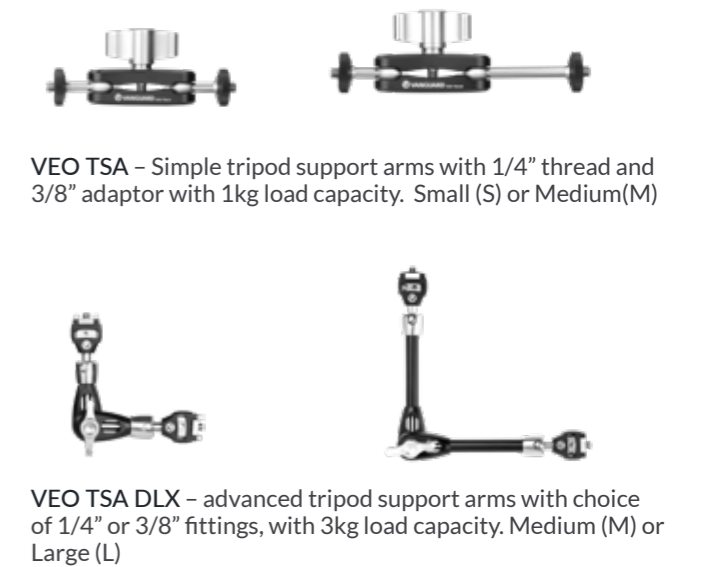

VEO TC - Tablet Connector

Solid aluminium design with Arca-compatible or 1/4" thread base, easy twist lock system and cold shoe seat on the top, this is a versatile tablet connector that can be used on a tripod, head, support arm or standalone. Fits tablets up to 220cm/12inches wide



MODEL	STANDARD HEIGHT [INCHES MM]	FOLDED HEIGHT [INCHES MM]	MAX LOAD [LBS KG]	WEIGHT [LBS KG]
VEO TSA S	4.53 115	2.5 63.5	4.4 2	0.22 0.98
VEO TSA M	5.98 152	3.0 76.5	4.4 2	0.23 1.06
VEO TSA DLX M	7.09 180	4.45 113	6.6 3	0.48 2.17
VEO TSA DLX L	11.42 290	6.57 167	6.6 3	0.59 2.67

MODEL	LENGTH [INCHES MM]	WIDTH [INCHES MM]	HEIGHT [INCHES MM]	MAX LOAD [LBS KG]	WEIGHT [LBS KG]
VEO CSM	-	0.97 24.7	1.1 27.9	-	0.05 0.25
VEO CSM DLX	-	1.22 31	2.24 57	-	0.19 0.815
VEO CSMM2	4.72 120	1.75 44.5	2.0 50.8	4.4 2	0.41 1.85
VEO CSMM3	3.44 87.4	0.87 22	1.14 29	4.4 2	0.19 86
VEO TC M	2.13 54	1.85 47	6.02 153	-	0.65 310

ACCESSORY VEO SPH | SMARTPHONE HOLDER

Versatile, multi-angular smartphone holder that can fit any smartphone between 60mm/2.36in. and 90mm/3.54in. wide and weighs just 180g/0.4lbs.

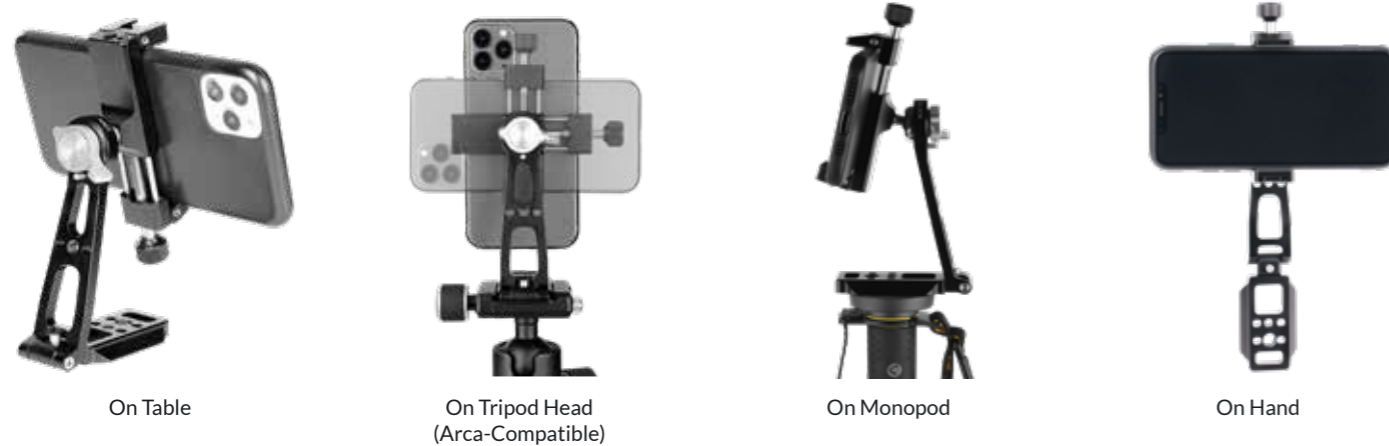

MODEL	LENGTH [INCHES MM]	WIDTH [INCHES MM]	HEIGHT [INCHES MM]	MAX LOAD [LBS KG]	WEIGHT [LBS KG]	SIZE RANGE [INCHES MM]
VEO SPH	3.6 91.0	3.1 78	4.3 110	8.8 4	0.4 0.18	2.2-3.5 57-90

ACCESSORY VEO CP | CLAMP

Attach your camera, smartphone or accessory to the surfaces around you, wherever you are, to get that perfect shot.



*VEO CP-65 VEO CP-46 up to 46mm; VEO CP-65 up to 65mm



ACCESSORY VEO CP KIT | CREATIVE PHOTO KIT

Clamp + Magic Arm + Smartphone Holder = Your camera/smartphone can be connected to many objects around you, offering more shooting angles and enabling you to capture more wonderful moments.

VEO CP-46 KIT



VEO CP-65 KIT



MODEL	LENGTH [INCHES MM]	WIDTH [INCHES MM]	HEIGHT [INCHES MM]	MAX LOAD [LBS KG]	WEIGHT [LBS KG]	SIZE RANGE [INCHES MM]
VEO CP-65	3.3 82.5	0.8 20	3.5 89.0	5.5 2.5	0.4 0.159	2.6 65
VEO CP-46	2.7 68.0	0.8 20	3.3 82.5	3.3 1.5	0.3 0.132	1.8 46
SMARTPHONE HOLDER			VEO SPH			
SUPPORT ARM M			VEO TSA DLX M			
SUPPORT ARM L			VEO TSA DLX L			
VEO CP-46 KIT			VEO CP-46 + VEO SPH + VEO TSA DLX M			
VEO CP-65 KIT			VEO CP-65 + VEO SPH + VEO TSA DLX L			

ACCESSORY VEO QS-360

VEO QS-360 is a panning quick-release plate that is designed to offer precision horizontal panning with the option to quickly detach with your camera. QS-360 features a built-in Arca-compatible base, allowing you to mount it onto any Arca-style ball head or pan head.



- Arca-compatible • 360° quick shoe • Dual axis • 1/4" camera screw & pin with D-ring

MODEL	LENGTH [INCHES MM]	WIDTH [INCHES MM]	HEIGHT [INCHES MM]	QUICK SHOE	FRONTAL TILT °	LATERAL TILT °	SWIVEL °	MAX LOAD [LBS KG]	WEIGHT [LBS KG]
VEO QS-360	4.1 105	2.2 55	1.6 40	QS-76/QS-62V3	-	-	360	22 10	0.5 0.24

ACCESSORY VEO LVL-60

Vanguard's new VEO LVL-60 is a leveling accessory that adjusts/tilts 15 degrees in all directions to give you easy, smooth movement and flexibility to follow your subject when it's on the move. An easy-locking knob lets you make quick adjustments in the field, and a 3/8" screw lets you mount your favorite ball or pan head.



MODEL	LENGTH [INCHES MM]	BOWL DIAMETER [INCHES MM]	HEIGHT [INCHES MM]	HEAD BASE [INCHES MM]	FRONTAL TILT °	LATERAL TILT °	SWIVEL °	MAX LOAD [LBS KG]	WEIGHT [LBS KG]
VEO LVL-60	3.51 90	2.56 65	1.97 50	2.28 58	15°~15°	15°~15°	360	33 15	0.7 0.32

ACCESSORY VEO BT-II

A Bluetooth remote to pair with your smartphone for hands-free shutter triggering. Works with iOS and Android devices.

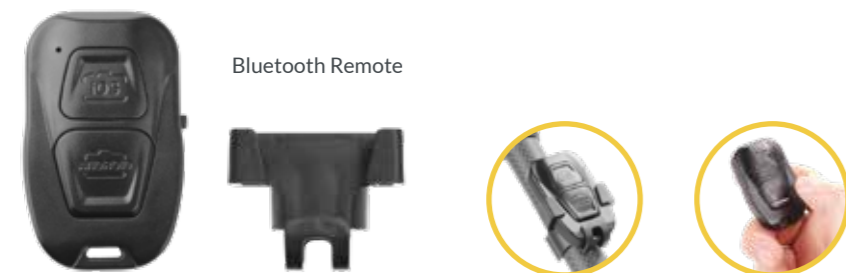

MODEL	LENGTH [INCHES MM]	WIDE [INCHES MM]	HEIGHT [INCHES MM]
VEO BT-II	1.34 34	0.51 13	2.13 54

QUICK SHOES

QS quick release plates make attaching and removing your camera a breeze, securely keeping your gear in position

Model	Compatible Heads	Features
QS-72T	VEO BP-120T [HEAD] [VEO 3T 265HABP] [VEO 3T 265HCBP] [VEO 2SCM-264TBP120T] VEO BP-50T [HEAD] [VEO 3T 235ABP] [VEO 3T 235CBP] [VEO 3TT 233ABP] [VEO 3TT 233CBP] [VEO 2SAM-234TBP50T] VEO BP-45T [HEAD] [VEO 3T 204ABP/CBP] [VEO 3TT 203ABP]	<ul style="list-style-type: none"> • Smartphone holder • 1/4" camera screw & pin with D-ring • Arca compatible
QS-74	VEO PH-38S [HEAD] [VEO 3+ 263APS] [VEO 3+ 263CPS] [VEO 3T+ 264APS] [VEO 3T+ 264CPS] [VEO 3 303APS] [VEO 3 303CPS] [VEO 3 263APS] [VEO 3 263CPS] VEO PH-36S [HEAD] [VEO 3T+ 234APS] [VEO 3T+ 234CPS] [VEO 3 233APS] [VEO 3 233CPS]	<ul style="list-style-type: none"> • 1/4" camera screw & pin with D-ring • Arca compatible
QS-60V2	ALTA BH-100 [HEAD] [ALTA PRO 2+ 263AB100] [ALTA PRO 2+ 263CB100] ALTA PH-32 [HEAD] [ALTA PRO 2+ 263AP] ALTA GH-100 [HEAD] [ALTA PRO 2+ 263AGH] ALTA PH-31 [HEAD] [ALTA PRO 2 264AO] VEO BH-160 [HEAD] [VEO 3+ 263AB] [VEO 3+ 263CB] BH-102H [HEAD] [VEO3GO265HAB] [VEO3GO265HCB]	<ul style="list-style-type: none"> • 1/4" camera screw & pin with D-ring • Arca compatible
QS-71P	VEO PH-28 [HEAD] [VEO 3 263AO] [VEO 3 263CO]	<ul style="list-style-type: none"> • 1/4" camera screw & pin with D-ring • Arca compatible
QS-65	VEO 2PH-38 [HEAD] [VEO 3+ 263AP] [VEO 3+ 263CP] T-50 [HEAD] [VEO 3GO 235AB] [VEO 3GO 235CB] T-45 [HEAD] [VEO 3GO 204AB] [VEO 3GO 204CB] T-51 [HEAD] [VESTA TB 235AB] [VESTA TB 235CB] T-46 [HEAD] [VESTA TB 204AB] [VESTA TB 204CB]	<ul style="list-style-type: none"> • 1/4" camera screw & pin with D-ring • Arca compatible
QS-65GH	GH-100 [HEAD] [ALTA PRO 263AGH]	<ul style="list-style-type: none"> • 1/4" camera screw & pin with D-ring • Arca compatible
QS-67	VEO PV-20 [HEAD] [ALTA PRO 3VRL 303AV20] [ALTA PRO 3VRL 303CV20] [ALTA PRO 3VL 303AV20] [ALTA PRO 3VL 303CV20]	<ul style="list-style-type: none"> • 1/4" camera screw in a removable slot & pin (coin to tighten) • Arca compatible
QS-39	SBH-100 [HEAD] [ALTA PRO 263AB 100]	<ul style="list-style-type: none"> • 1/4" camera screw & pin (coin to tighten)
QS-62V3	VEO BH-250S [HEAD] [VEO 3+ 303ABS] [VEO 3+ 303CBS] [VEO 3 303AB] [VEO 3 303CB] VEO BH-160S [HEAD] [VEO 3+ 263AB160S] [VEO 3+ 263CB160S] [VEO 3T+ 264AB] [VEO 3T+ 264CB] [VEO 3 263AB] [VEO 3 263CB] VEO BH-110S [HEAD] [VEO 3T+ 234AB] [VEO 3T+ 234CB] VEO QS-360 [ACCESSORY]	<ul style="list-style-type: none"> • 1/4" camera screw & pin with D-ring • Arca compatible
QS-61P	ALTA PH-114V [HEAD] [ALTA PRO 2 263AV] VEO PV-18 [HEAD] [ALTA PRO 3VRL 303AV18] [ALTA PRO 3VRL 303CV18] [ALTA PRO 3VL 303AV18] [ALTA PRO 3VL 303CV18] [VEO 3V 303AV18] [VEO 3V 303CV18] VEO PV-16 [HEAD] [ALTA PRO 3VL 263AV16] [ALTA PRO 3VL 263CV16] [VEO 3V 263AV16] [VEO 3V 263CV16]	<ul style="list-style-type: none"> • 1/4" camera screw in a removable slot & pin (coin to tighten) • Arca compatible
QS-29	PH-23 [HEAD] [VESTA 233AP] [VESTA 203AP] [VESTA 204AP] [VESTA 203APSPC] [VESTA 204APSPC] GH-45 [HEAD] [VESTA 203AGH]	<ul style="list-style-type: none"> • Anti-slip rubber pad • 1/4" camera screw & pin with D-ring



Since 1986, VANGUARD has been a part of the worldwide photo/video market and launched new products every year. We have been recognized by well-known awards all over the world, have worked with creators from all walks of life, and have sold our products in more than 80 countries.

Vanguard's large selection of camera trolley bags, backpacks, and messenger bags consists of three main families: **The Alta series**, which boasts advanced features geared toward professionals; **the VEO series**, which offers versatility, reliability, and cutting-edge designs for all types of users; and **the Vesta series**, our family of practical equipment designed for newcomers or those who just need a simple solution. With hundreds of different color and style choices, we are sure to have the right bag to carry your gear and configure it to your liking.

Bags, Trolleys & Cases



ALTA SKY PROFESSIONAL BACKPACKS-LONG-FOCUS

Alta Sky is a series of dynamic backpacks and daypacks with a new take on what versatility can offer a professional photographer. Vanguard's design team created a new standard in adaptable carrying and working solutions, enabling a simple transition from 100% gear to 100% personal and anywhere in between.



*ALTA SKY 68



*ALTA SKY 66



'Never-Tire' Carrying Experience

Stay Steady

SERIES HIGHLIGHTS

- Designed to carry up to an 800mm lens with pro-body attached
- Quick top access (with rear access to additional kit on the Alta Sky 68)
- Alta Sky 68 can also carry up to 7 additional lenses (or personal kit)
- Carry a full size tripod centrally for maximum comfort over extended distances



'Never-Tire' Carrying Experience



MODEL	INTERIOR DIMENSIONS (INCHES MM)	EXTERIOR DIMENSIONS (INCHES MM)	MAX LOAD (LBS KG)	WEIGHT (LBS KG)	FITS DEVICE	TABLET POCKET	LITER SIZE (L)
ALTA SKY 68	13.4 X 7.1 X 22.9 340 X 180 X 580	14.1 X 9 X 23.4 360 X 230 X 595	35.3 16.0	6.5 2.9	11" TABLET 16" LAPTOP	YES	36
ALTA SKY 66	10.2 X 9.4 X 24 260 X 240 X 610	11.3 X 11.3 X 24.3 290 X 290 X 620	23.1 10.5	5.5 2.5	11" TABLET	YES	30

ALTA SKY PROFESSIONAL BACKPACKS-OUTDOORS

Alta Sky is a series of dynamic backpacks and daypacks with a new take on what versatility can offer a professional photographer. Vanguard's design team created a new standard in adaptable carrying and working solutions, enabling a simple transition from 100% gear to 100% personal and anywhere in between.

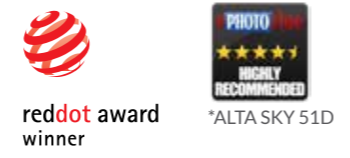

*ALTA SKY 53



*ALTA SKY 51D



*ALTA SKY 45D



ALTA SKY 53



ALTA SKY 45D

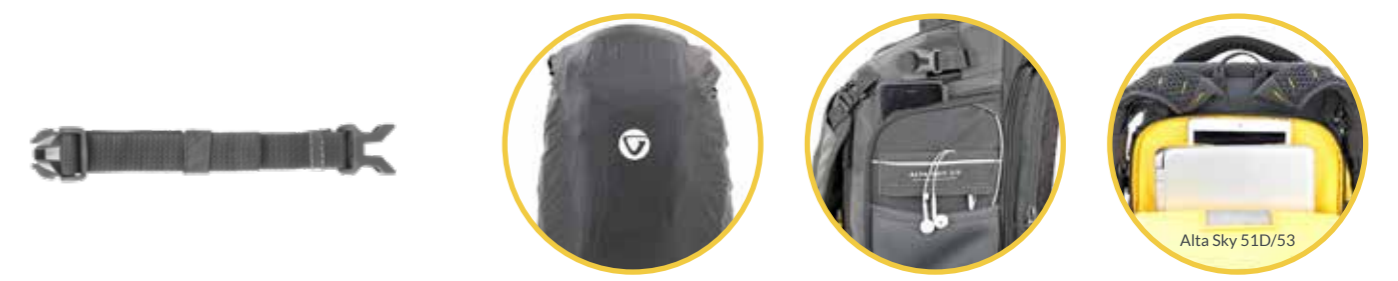

Quick Access



'Never-Tire' Carrying Experience

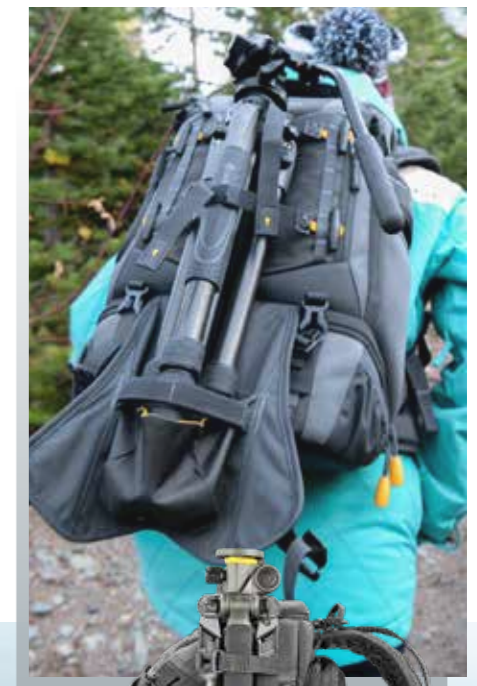

Stay Steady



ALTA SKY 45D/51D



SERIES HIGHLIGHTS

- Ultimate versatility - 100% gear to 100% personal and anywhere in between
- Multi-access quick-action - full rear opening and top access | + Side access in daypacks
- Drone action - dual use/dual color dividers for drone set-up*
- Business oriented - All bags have laptop or tablet carry ability (see chart for details)
- No fumbling - bright colored interior makes finding things easy

MODEL	INTERIOR DIMENSIONS [INCHES MM]	EXTERIOR DIMENSIONS [INCHES MM]	MAX LOAD [LBS KG]	WEIGHT [LBS KG]	FITS DEVICE	TABLET POCKET	LITER SIZE [L]
ALTA SKY 53	12.6 X 7.8 X 20.8 320 X 200 X 530	15 X 10.6 X 22.8 380 X 270 X 580	35.2 16.0	6.2 2.8	17" LAPTOP	YES	34
ALTA SKY 51D	12.6 X 7.8 X 20 320 X 200 X 510	14.6 X 10.2 X 22.2 370 X 260 X 565	29.7 13.5	6.4 2.9	15" LAPTOP	YES	32
ALTA SKY 45D	10.2 X 7.5 X 17.7 260 X 190 X 450	12.2 X 9 X 19.5 310 X 230 X 495	19.8 9.0	4.8 2.2	13" LAPTOP	YES	22

VEO ACTIVE ADVENTURE BACKPACKS

VEO ACTIVE bags are a sure fit for photographers on the go, as well as hikers, campers, birdwatchers - practically any outdoor adventurer. Dual-laminated 840D nylon ripstop materials protect your bag from the elements, as well as the wear and tear brought on by the natural world, while carrying a large load of camera bodies and lenses (or camping gear) in comfort over longer distances.



Waist Belt (except Veo Active 42M)



*VEO ACTIVE 53



*VEO ACTIVE 53

Inner Box (except Veo Active Birder 56)

'Never-Tire' Carrying Experience

Stay Steady



Reinforced and designed to fit the shape of your back.



Top compartment

Waist cushion and Aluminum alloy frame to fit torso

SERIES HIGHLIGHTS

- Waterproof material
- Quick water pouch access design
- Trolley sleeve included
- Shoulder strap pockets
- Full sized tripod holder

COLOR:

MODEL	INTERIOR DIMENSIONS (INCHES MM)	EXTERIOR DIMENSIONS (INCHES MM)	MAX LOAD (LBS KG)	WEIGHT (LBS KG)	FITS DEVICE	LITER SIZE (L)
VEO ACTIVE 53	12.2 X 7.1 X 20.9 310 X 180 X 530	12.9 X 9.8 X 21.7 330 X 250 X 550	44.1 20	6.52 2.96	10" TABLET 16" LAPTOP	45
VEO ACTIVE 49	12.2 X 7.1 X 19.3 310 X 180 X 490	12.9 X 9.8 X 20.1 330 X 250 X 510	35.3 16	6.22 2.82	10" TABLET 15" LAPTOP	35
VEO ACTIVE 46	10.6 X 6.3 X 18.1 270 X 160 X 460	11.4 X 9.1 X 18.7 290 X 230 X 475	24.2 11	5.60 2.54	10" TABLET 14" LAPTOP	25
VEO ACTIVE 42M	9.8 X 5.9 X 17.7 250 X 150 X 420	10.6 X 7.5 X 17.3 270 X 190 X 440	18.7 8.5	4.32 1.96	10" TABLET 13" LAPTOP	17

VEO SELECT TROLLEY BAGS THAT CONVERT TO BACKPACKS/SHOULDER BAGS

Vanguard's innovative VEO SELECT Trolley Bag series comes in three sizes and two colors, all designed to be airline carry-on friendly*. Features include a stylish look, durable materials, multiple pockets, and customizable storage solutions for pro-level kits (including tripod(s), four (55BT/58T) or two wheels (59T) and a backpack harness system.

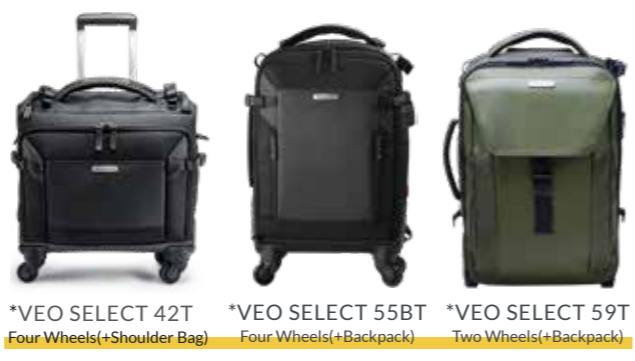

Veiled VEO Select 42T's Shoulder Strap



Veiled VEO Select 55BT
Veiled VEO Select 58T (Veiled VEO Select 59T is similar)
Veiled Stay Steady

*VEO SELECT 58T Four Wheels(+Backpack)



Inner Box (Veiled VEO Select 55BT/58T)



Top Quick Action (VEO Select 42T)



SERIES HIGHLIGHTS

- Strong, high quality material that is scratch and water resistant (with rain cover when needed), and double handle for maximum strength
- All designed to meet IATA airline carry-on luggage guidelines (2020)
- All models are designed to carry a tripod
- Well organized – numerous dividers, dedicated pockets and organization
- All bags double as luggage; simply remove the interior divider compartment
- All models convert to backpacks to cover uneven ground, except the VEO Select 42T which converts to a shoulder bag

COLOR :

MODEL	INTERIOR DIMENSIONS (INCHES MM)	EXTERIOR DIMENSIONS (INCHES MM)	MAX LOAD (LBS KG)	WEIGHT (LBS KG)	FITS DEVICE	LITER SIZE (L)
VEO SELECT 59T	13 X 6.8 X 18.5 330 X 170 X 470	14.2 X 8.7 X 21.5 360 X 220 X 545	33.1 15	9.22 4.18	11" TABLET 17" LAPTOP	26
VEO SELECT 58T	11.8 X 6.9 X 18.5 300 X 175 X 470	14.2 X 10.2 X 24 360 X 260 X 610	33.1 15	11.24 5.10	11" TABLET 16" LAPTOP	26
VEO SELECT 55BT	12.3 X 6.3 X 17.5 310 X 160 X 445	14.2 X 8.2 X 22.1 360 X 220 X 560	27.6 12.5	9.52 4.32	11" TABLET 15" LAPTOP	22
VEO SELECT 42T	14.6 X 6.3 X 13 370 X 160 X 330	16.5 X 9.9 X 17.9 420 X 250 X 455	26.5 12	8.55 3.88	11" TABLET 15" LAPTOP	20

*Airline carry-on regulations are subject to change and vary by airline and country. To meet the requirements, you may need to remove laptops, tripod holders, and attachments. Call your airline or visit its website for current size and weight restrictions.

VEO SELECT CLASSIC BACKPACKS

VEO Select 45BFM and 48BF are classic backpacks that fit a camera with up to 7-8 lenses and a 15" laptop.



*VEO SELECT 45BFM



*VEO SELECT 48BF

*VEO SELECT 45BFM



Side Quick Action

Stay Steady

Versatile

Ergonomic Design



SERIES HIGHLIGHTS

- Always supported- VEO tripod carry-along integrated solutions inside and outside
- Double connectivity- extra strap connection up front or on the bottom
- Keep dry - total coverage rain cover
- Incognito - no one needs to know this is a camera bag
- Safe storage - secure rear pocket for travel document and wallet
- Set-up versatility- with plenty of dividers and inserts to allow 100% gear or 100% personal, depending on the user

COLOR:

MODEL	INTERIOR DIMENSIONS [INCHES MM]	EXTERIOR DIMENSIONS [INCHES MM]	MAX LOAD [LBS KG]	WEIGHT [LBS KG]	FITS DEVICE	LITER SIZE [L]
VEO SELECT 48BF	11.8 X 6.5 X 18.9 300 X 165 X 480	13.3 X 9.6 X 20.5 335 X 245 X 520	25.57 11.6	4.28 1.94	11" TABLET 15" LAPTOP	24
VEO SELECT 45BFM	10.6 X 5.1 X 16.9 270 X 130 X 430	11.8 X 8.3 X 18.3 300 X 210 X 465	19.18 8.7	3.26 1.48	11" TABLET	15



VEO SELECT SLIM BACKPACKS

VEO Select 37BRM and 46BR measure just 28cm wide, but they don't compromise on how much kit they can hold. With fast side access on either side, these bags are perfect for left- or right-handed photographers.



*VEO SELECT 46BR



*VEO SELECT 37BRM



Ergonomic Design

Two Side Quick Action

Versatile

Stay Steady

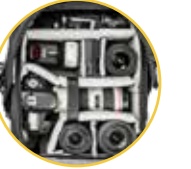

VEO SELECT BACKPACKS/SHOULDER BAGS

VEO Select 41, 45M and 49 are slim and stylish backpacks with a top section for personal kit, and they convert to a shoulder bag in seconds.



*VEO SELECT 49

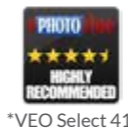

*VEO Select 41



*VEO SELECT 41/45M



Ergonomic Design

Two Side Quick Action

Versatile

Stay Steady

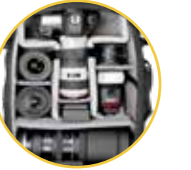

SERIES HIGHLIGHTS

- Always supported- VEO tripod carry-along integrated solutions inside and outside
- Double connectivity- extra strap connection up front or on the bottom
- Keep dry - total coverage rain cover
- Incognito - no one needs to know this is a camera bag
- Safe storage - secure rear pocket for travel document and wallet
- Set-up versatility- with plenty of dividers and inserts to allow 100% gear or 100% personal, depending on the user

COLOR:

MODEL	INTERIOR DIMENSIONS [INCHES MM]	EXTERIOR DIMENSIONS [INCHES MM]	MAX LOAD [LBS KG]	WEIGHT [LBS KG]	FITS DEVICE	LITER SIZE [L]
VEO SELECT 46BR	9.9 X 5.9 X 18.1 250 X 150 X 460	11.0 X 8.3 X 18.7 280 X 210 X 475	19.8 9.0	3.04 1.38	13" LAPTOP	17
VEO SELECT 37BRM	10.0 X 4.5 X 14.6 255 X 115 X 370	11.0 X 6.9 X 15.4 280 X 175 X 390	9.3 4.2	2.38 1.08	11" TABLET	11
VEO SELECT 49	11.3 X 4.9 X 19.2 290 X 125 X 490	13.3 X 8.1 X 19.9 340 X 205 X 505	20.28 9.2	3.66 1.66	15" LAPTOP	18
VEO SELECT 45M	10.9 X 4.4 X 17.7 275 X 110 X 450	12.6 X 7.5 X 18.1 320 X 190 X 460	17.19 7.8	3.33 1.51	15" LAPTOP	14
VEO SELECT 41	10.9 X 4.9 X 16.1 275 X 125 X 410	12.6 X 8.1 X 16.5 320 X 205 X 420	11.9 5.4	3.37 1.53	13" LAPTOP	14



VEO SELECT ROLL-TOP BACKPACKS

The VEO SELECT 39RBM/43RB is a stylish roll-top backpack with a full front opening to the gear compartment and a flexible wide-opening top personal compartment. It is ideal for enthusiastic image makers who want to carry as much as possible in a compact, stylish fashion that does not shout, "I am a camera bag!"



*VEO SELECT 43RB



*VEO SELECT 43RB *VEO SELECT 39RBM



- Hanging On
- Stay Steady
- Versatile
- Ergonomic Design



SERIES HIGHLIGHTS

- Always supported- VEO tripod carry-along integrated solutions inside and outside
- Double connectivity- extra strap connection up front or on the bottom
- Keep dry - total coverage rain cover
- Incognito - no one needs to know this is a camera bag
- Safe storage - secure rear pocket for travel document and wallet
- Set-up versatility- with plenty of dividers and inserts to allow 100% gear or 100% personal, depending on the user



COLOR:

MODEL	INTERIOR DIMENSIONS [INCHES MM]	EXTERIOR DIMENSIONS [INCHES MM]	MAX LOAD [LBS KG]	WEIGHT [LBS KG]	FITS DEVICE	LITER SIZE [L]
VEO SELECT 43RB	9 X 4.9 X 16.5 230 X 125 X 420	12.3 X 8.1 X 18.5 310 X 205 X 470	16.5 7.5	2.76 1.25	11" TABLET	12
VEO SELECT 39RBM	8.3 X 4 X 15 210 X 100 X 380	10.7 X 6.8 X 16.9 270 X 170 X 430	9.3 4.2	2.36 1.07	11" TABLET	8

VEO SELECT SHOULDER BAGS

VEO Select 22S, 28S and 36S shoulders bags are designed to carry your gear in comfort, while offering fast access when you need it



*VEO SELECT 36S



*VEO SELECT 28S *VEO SELECT 22S



- Elevation Feet
- Stay Steady
- Versatile
- Fits With Belt (22S)



SERIES HIGHLIGHTS

- Shoulder and handle pad: effectively reduce carrying burden
- Keep dry - total coverage rain cover
- Trolley sleeve for hands free travel convenience
- Sturdy shoulder strap with metal buckle
- Quality material is strong & water/scratch resistant

COLOR:

MODEL	INTERIOR DIMENSIONS [INCHES MM]	EXTERIOR DIMENSIONS [INCHES MM]	MAX LOAD [LBS KG]	WEIGHT [LBS KG]	FITS DEVICE	LITER SIZE [L]
VEO SELECT 36S	14.6 X 6.9 X 9.0 370 X 175 X 230	15.8 X 9.9 X 11.4 400 X 250 X 290	24.2 11	3.70 1.68	13" LAPTOP	15
VEO SELECT 28S	11.0 X 6.5 X 9.0 280 X 165 X 230	12.8 X 9.0 X 11.0 325 X 230 X 280	15.4 7	3.06 1.39	11" TABLET	10
VEO SELECT 22S	9.3 X 4.8 X 7.3 235 X 120 X 185	10.6 X 6.8 X 9.0 270 X 170 X 230	6.6 3	1.68 0.76	7.9" TABLET	5



VEO CITY CB CROSS BODY BAG

VEO CITY is a collection of bags that delivers a sleek, modern design to match your style, while being packed with innovative storage solutions and keeping it all safe inside. The VEO CITY Cross Body (CB) bag is designed to be an all-in-one bag that oozes style. It can organize and carry all your photography kit or your vlogging kit, from lenses to cables. The cross-body shoulder design then allows you to position the bag in the most comfortable position, whether walking or in use. The VEO CITY Cross Body (CB) bags can carry a travel tripod.



*VEO CITY CB 29

*VEO CITY CB 24



*VEO CITY CB 34

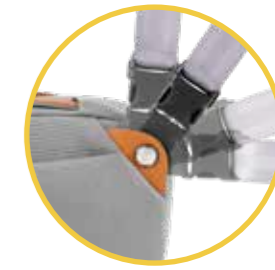

Versatile

'Never-Tire' Carrying Experience

Stay Steady

SERIES HIGHLIGHTS

- Tough internal frame and water-resistant exterior
- Expanding Carry Handle
- Internal pockets made of 4-way stretch fabric
- The charging port
- Stitch free for a sleek and premium finish
- Shoulder/waist strap & magnetic buckle
- Flexible storage space
- Tablet space
- Rain cover for full water protection
- Slimline smart dividers
- Carry a support wherever you go
- Trolley sleeve (CB34 available)

COLOR :

MODEL	INTERIOR DIMENSIONS (INCHES MM)	EXTERIOR DIMENSIONS (INCHES MM)	MAX LOAD (LBS KG)	WEIGHT (LBS KG)	FITS DEVICE	LITER SIZE (L)
NEW VEO CITY CB 34	11.4-13 X 3.9 X 9.3 290-330 X 100 X 235	13.8 X 5.8 X 9.9 350 X 145 X 250	18.7 8.5	2.25 1.02	12.9" TABLET	8
NEW VEO CITY CB 29	10.3-11.4 X 3.5 X 7.9 260-290 X 90 X 200	12.3 X 5.4 X 8.5 310 X 135 X 215	11.0 5	1.81 0.82	8.3" TABLET	6
NEW VEO CITY CB 24	8.6-9.5 X 3.1 X 5.8 220-240 X 80 X 140	10.3 X 4.8 X 6.3 260 X 120 X 160	5.5 2.5	1.28 0.58	-	3



Hanging On



Versatile Divider



VEO CITY TP TECH POUCH

VEO CITY TP is a collection of useful tech pouches that can make carrying your gear a lot easier. The VEO CITY Tech Pouch (TP) is designed to be a multifunctional bag that doubles as a fashion accessory. It can organize and carry all your photography accessories or your vlogging kit, or any other kit you need on the go, from a first-aid kit to a handbag/manbag. TP models are perfect for carrying a gimbal or selfie stick, for vloggers on the go with smartphones or compact cameras.



*VEO CITY TP 28

*VEO CITY TP 23



*VEO CITY TP 33



Versatile

'Never-Tire' Carrying Experience

Stay Steady

SERIES HIGHLIGHTS

- Tough internal frame and water-resistant exterior
- Expanding carry handle
- Internal pockets made of 4-way stretch fabric
- Laptop/tablet space (up to 13")
- Stitch free for a sleek and premium finish
- Removable shoulder straps
- Flexible storage space
- Trolley sleeve (TP32 available)
- Rain cover for full water protection
- Slimline smart dividers
- Carry a support wherever you go

COLOR:

MODEL	INTERIOR DIMENSIONS (INCHES MM)	EXTERIOR DIMENSIONS (INCHES MM)	MAX LOAD (LBS KG)	WEIGHT (LBS KG)	FITS DEVICE	LITER SIZE (L)
NEW VEO CITY TP 33	13.4 X 3.8 X 9.9 340 X 95 X 250	14.1 X 6.5 X 10.6 360 X 165 X 270	17.6 8	2.60 1.18	12.9" TABLET 13" LAPTOP	8
NEW VEO CITY TP 28	11 X 3.4 X 6.8 280 X 85 X 170	11.8 X 4.8 X 7.6 300 X 120 X 195	6.6 3	1.54 0.70	8.3" TABLET	4
NEW VEO CITY TP 23	9 X 3.4 X 5.5 230 X 85 X 140	9.9 X 4.8 X 6.3 250 X 120 X 160	4.4 2	1.23 0.56	-	2.5

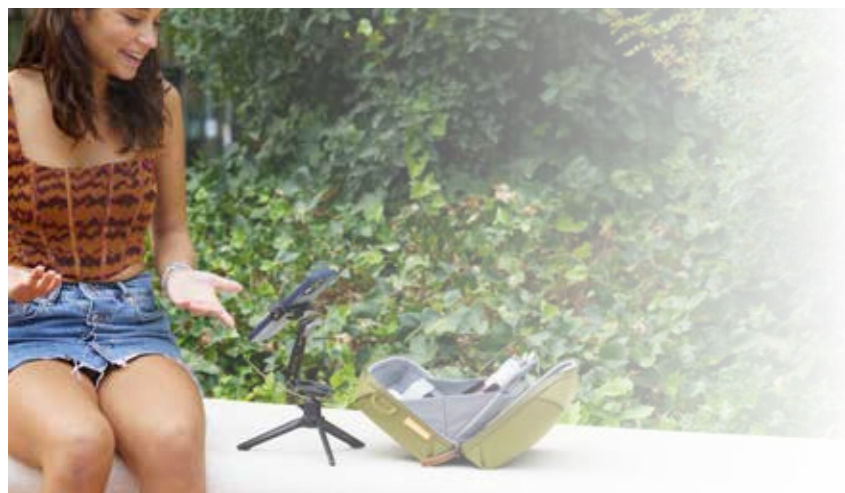

VEO RANGE T BACKPACKS

Choosing between your daily bag and your camera bag can be quite a tough decision. Whether you are staying close to home or venturing out, with VEO RANGE messenger bags and daypacks, this need no longer be of concern. The amazing functional versatility of these bags allows you to safeguard a variety of photo or video gear alongside your personal effects. Due to the casual design of this series, by simply removing the gear, inserts or dividers, you have a great stylish and spacious everyday carrying solution.



SERIES HIGHLIGHTS

- Well thought out design and structure can carry heavy gear
- Multiple access points for quick access to gear
- Laptop sleeve for up to 13.4" laptop
- Trolley sleeve for convenience while travelling
- High quality water resistant material and total coverage rain cover
- Customizable interior and external webbing
- Multiple pockets for additional accessories
- Includes: two buckle straps, removable tripod foot pocket, water bottle bag, and rain cover



COLOR:

MODEL	INTERIOR DIMENSIONS [INCHES MM]	EXTERIOR DIMENSIONS [INCHES MM]	MAX LOAD [LBS KG]	WEIGHT [LBS KG]	FITS DEVICE	LITER SIZE [L]
VEO RANGE T48	11.8 X 7.5 X 18.9 300 X 190 X 480	12.8 X 9.9 X 19.6 325 X 250 X 500	25.4 11.5	4.80 2.18	15.6" LAPTOP	27
VEO RANGE T45M	11.0 X 5.1 X 17.8 280 X 130 X 450	11.8 X 7.5 X 18.5 300 X 190 X 470	22.0 10	4.14 1.88	13.4" LAPTOP	16
VEO RANGE T37M	10.0 X 4.5 X 14.6 255 X 115 X 370	11.0 X 7.1 X 15.4 280 X 180 X 390	15.4 7.0	3.02 1.37	11" LAPTOP	11

VEO RANGE SHOULDER BAGS

Choosing between your daily bag and your camera bag can be quite a tough decision. Whether you are staying close to home or venturing out, with VEO RANGE shoulder bags, this need no longer be of concern. The amazing functional versatility of these bags allows you to safeguard a variety of photo or video gear alongside your personal effects. Due to the casual design of this series, by simply removing the gear, inserts or dividers, you have a great stylish and spacious everyday carrying solution.

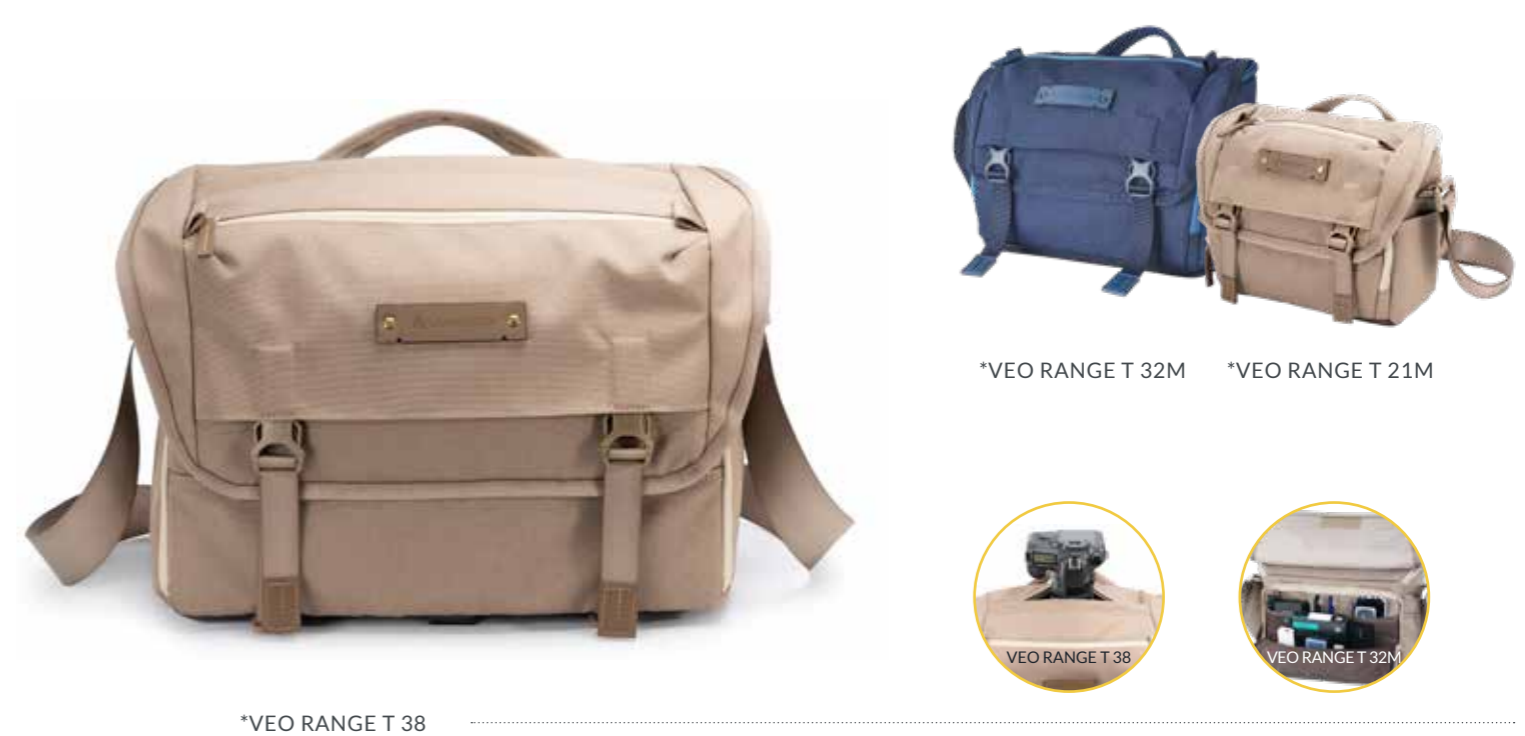

SERIES HIGHLIGHTS

- DOUBLE DECKER (Only VEO Range 38) - Unique shoulder bags with upper deck; perfect for main photo, video, or drone gear, and lower deck; ideal to carry tripod inside, or additional accessories: gimbal, drone, video light panels, audio kit, etc.
- Always supported- VEO tripod carry-along integrated solutions inside (Only VEO Range 38) and outside
- Keep dry - total coverage rain cover
- Double Connectivity- extra strap connection up front or on the bottom (Only VEO Range 38)
- Set-up Versatility- with plenty of dividers and inserts to allow 100% gear or 100% personal, depending on the user
- Safe storage - secured rear pocket for travel document and wallet
- Incognito - no one needs to know this is a camera bag



COLOR:

MODEL	INTERIOR DIMENSIONS [INCHES MM]	EXTERIOR DIMENSIONS [INCHES MM]	MAX LOAD [LBS KG]	WEIGHT [LBS KG]	FITS DEVICE	LITER SIZE [L]
VEO RANGE 38	15.1 X 5.7 X 11.7 385 X 145 X 300	16.8 X 8.2 X 13.3 430 X 210 X 340	15.9 7.2	2.64 1.20	15" LAPTOP	17
VEO RANGE 32M	12.6 X 5.3 X 9.1 320 X 135 X 230	14.2 X 6.5 X 9.8 360 X 165 X 250	12.1 5.5	1.85 0.84	12.9" TABLET	10
VEO RANGE 21M	9.2 X 4.4 X 7.5 235 X 110 X 190	10.6 X 6.3 X 8.6 270 X 160 X 220	6.2 2.8	1.06 0.48	7.9" TABLET	5

VEO ADAPTOR BACKPACKS FOR POWER ON THE GO

The new VEO Adaptor backpacks include an external USB interface opening – so you can stay charged and connected on the go. In addition they include large access openings and increased waterproofing to keep your equipment safe yet accessible. They are comfortable with thick padded handles for easy carrying. As with all Vanguard photography bags, the Adaptor series offers numerous options for internal configurations, so you can find your optimal setup based on your rig. Carry a laptop or tablet as well as your camera and lenses, memory cards, and other accessories – adapt your bag for your needs. Enjoy more variety with the new VEO Adaptor bags, which are available in two sizes and two colors, as well as rear-opening and side-opening models – making eight total choices.



*VEO ADAPTOR R48



*VEO ADAPTOR S41/46 Both Sides open

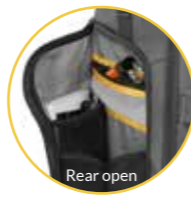

Rear open



*VEO ADAPTOR R44/48 Rear open

Stay Steady

Rear Opening

Side Opening

Ergonomic Design

SERIES HIGHLIGHTS

- Top mesh pocket to store small accessories
- Optimized to carry a tripod comfortably
- Keep dry - total coverage rain cover
- Front pocket is hidden from sight

COLOR:

MODEL	INTERIOR DIMENSIONS (INCHES MM)	EXTERIOR DIMENSIONS (INCHES MM)	MAX LOAD (LBS KG)	WEIGHT (LBS KG)	FITS DEVICE	LITER SIZE (L)
VEO ADAPTOR R48	10.3 X 6.3 X 18.0 260 X 160 X 480	11.4 X 8.6 X 19.3 290 X 220 X 490	25.4 11.5	3.22 1.46	16" MAC BOOK	20
VEO ADAPTOR R44	8.6 X 6.3 X 16.9 220 X 160 X 430	10.3 X 8.6 X 17.8 260 X 220 X 450	19.8 9.0	2.78 1.26	13" MAC BOOK	16
VEO ADAPTOR S46	9.5 X 6.3 X 17.8 240 X 160 X 450	10.6 X 8.8 X 18.3 270 X 220 X 465	18.7 8.5	3.02 1.37	15" MAC BOOK	18
VEO ADAPTOR S41	7.9 X 5.9 X 16.1 200 X 150 X 410	9.5 X 8.3 X 16.5 240 X 210 X 420	11.5 5.2	2.53 1.15	10" PAD	12



VEO ADAPTOR SHOULDER BAGS

The VEO Adaptor Shoulder Bag series is designed to carry and protect your camera kit with ease. The modern design applies high-quality, tear- and water-resistant material with a waterproof zipper for a high level of protection on the go. Designed to carry up to a camera with 2-3 lenses (or a small drone), VEO Adaptor is packed with additional storage pockets for all the accessories you need. All this and easy to carry with a choice of handle or shoulder strap, with a belt sleeve to keep the bag close and secure as you travel.



*VEO ADAPTOR 24M



*VEO ADAPTOR 15M

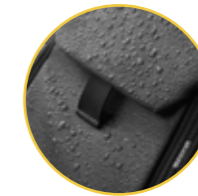

Rain Cover

Stay Steady

Versatile

Fits With Belt

SERIES HIGHLIGHTS

- Reflective stitching - Safer to carry in the dark
- Up to 8" tablet (VEO Adaptor 24M)
- Top waterproof zip pocket - Store paper, cards, and more
- Waterproof and highly snag-resistant
- Elastic side pockets - Store small accessories
- Extra padded waist sleeve - Attaching to waist belt for better mobility

COLOR:

MODEL	INTERIOR DIMENSIONS (INCHES MM)	EXTERIOR DIMENSIONS (INCHES MM)	MAX LOAD (LBS KG)	WEIGHT (LBS KG)	FITS DEVICE	LITER SIZE (L)
VEO ADAPTOR 24M	8.9 X 4.5 X 6.3 225 X 115 X 160	9.8 X 5.9 X 9.1 250 X 150 X 230	25.4 11.5	0.97 0.44	8" TABLET	4.1
VEO ADAPTOR 15M	7.1 X 4.1 X 5.9 180 X 105 X 150	8.3 X 5.3 X 8.7 210 X 135 X 220	19.8 9.0	0.71 0.32	-	2.8



VEO GO BACKPACKS/SHOULDER BAGS

Having your camera with you no matter where you are is key to shooting that memorable experience. VEO GO is a dedicated mirrorless/CSC/hybrid camera bag series, classically stylish with a fresh urban traveler look that does not shout, "I am a camera bag!" All models are super-compact, yet spacious inside. And they are feature-rich, offering second-to-none gear protection alongside plenty of pockets for your important personal daily or travel needs. The backpacks can easily transform into regular daypacks.

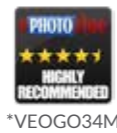

*VEOGO34M



*VEO GO 34M/24M/15M Shoulder bags

*VEO GO 21M Shoulder bags

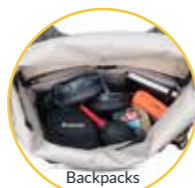

Backpacks

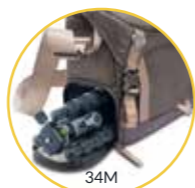

34M



34M

*VEO GO 46M/42M Backpacks

Stay Steady



Backpacks Rear Opening



Shoulder Bags Opening



Ergonomic Design



SERIES HIGHLIGHTS

- VEO GO 34M can carry VEO 3GO 204/235 travel tripods in the internal tripod compartment for a discreet solution on the go
- Snug and protective - perfectly sized to fit for mirrorless/CSC/hybrid camera models
- Easy & secure access-shoulder bags open away from the body for quick & easy access. Backpacks offer full rear opening for added security in crowds.
- Off the clock-easily transforms into an everyday backpack or shoulder bag
- Intuitive- straightforward setup for camera gear and personal effects

COLOR:

MODEL	INTERIOR DIMENSIONS [INCHES MM]	EXTERIOR DIMENSIONS [INCHES MM]	MAX LOAD [LBS KG]	WEIGHT [LBS KG]	FITS DEVICE	LITER SIZE [L]
VEO GO 46M	10.4 X 4.1 X 18.1	26.5 X 10.5 X 46.0	15.9 7.2	2.20 1.00	13" LAPTOP	13
VEO GO 42M	9.8 X 3.8 X 16.5	24.5 X 9.5 X 42.0	8.8 4.0	1.98 0.90	11" TABLET	9.8
VEO GO 34M	13.4 X 4.1 X 9.0	34.0 X 10.5 X 23.0	14.0 X 5.1 X 9.9	3.55 X 1.30 X 2.50	11" TABLET	8.2
VEO GO 24M	8.8 X 4.1 X 6.2	22.5 X 10.5 X 16.0	9.5 X 4.8 X 7.1	2.40 X 1.25 X 1.80	-	3.8
VEO GO 21M	8.3 X 4.1 X 7.5	21.0 X 10.5 X 19.0	10.6 X 5.8 X 8.3	2.70 X 1.45 X 2.10	7.9" TABLET	4.2
VEO GO 15M	7.1 X 4.1 X 6.2	18.0 X 10.5 X 16.0	7.6 X 4.8 X 7.1	1.95 X 1.25 X 1.80	-	3.0



VEO BIB T TOP ACCESS BAG-IN-BAG FOR SHOULDER BAGS

The VEO BIB T Series is a top access camera bag for smaller camera kits (up to 3 lenses), that is designed to fit into the bag of your choice. Being top access, it is ideally suited for a shoulder bag, but it can also be used to keep you camera safe between locations in any style of bag (such as in your everyday hand luggage) and then used on location as a lightweight shoulder bag in it's own right when you reach your destination.



*VEO BIB T 25



*VEO BIB T 22



*VEO BIB T 18



Trolley sleeve (T25)



Versatile



Shoulder Bags Opening



As Inner bag



SERIES HIGHLIGHTS

- Next-generation dividers with multi-folding styles
- Multiple pockets for accessories
- Water-resistant material
- Padded handle and shoulder strap
- Trolley sleeve (T25 only)

MODEL	INTERIOR DIMENSIONS [INCHES MM]	EXTERIOR DIMENSIONS [INCHES MM]	MAX LOAD [LBS KG]	WEIGHT [LBS KG]	LITER SIZE [L]		
VEO BIB T25	9.8 X 4.3 X 7.5	25.0 X 11.0 X 19.0	10.8 X 5.5 X 8.3	2.75 X 1.40 X 2.10	7.1 3.2	1.15 0.52	5.2
VEO BIB T22	8.7 X 3.9 X 6.3	22.0 X 10.0 X 16.0	9.8 X 5.1 X 7.3	2.50 X 1.30 X 1.85	6.2 2.8	0.88 0.40	3.5
VEO BIB T18	7.1 X 3.9 X 5.5	18.0 X 10.0 X 14.0	8.3 X 5.1 X 6.7	2.10 X 1.30 X 1.70	4.4 2.0	0.71 0.32	2.5



VEO BIB F FRONT ACCESS BAG-IN-BAG FOR BACKPACKS/ROLLER CASES

The VEO BIB F Series is designed to fit inside the backpack or roller case of your choice, allowing you to carry your camera gear inside a larger bag. With a choice of front access or top access in every model, these are ideal partners for the backpack of your choice. Alternatively, they can be carried separately using the comfortable handle or shoulder strap. Inside the slim, smart dividers can be tailored for your gear, and this doesn't need to be just for cameras and lenses. In addition there are multiple storage pockets for all the accessories you need, including up to a 11" tablet.



*VEO BIB F33 *VEO BIB F28 *VEO BIB F27



*VEO BIB F36

Trolley sleeve (Except F27)

Three Ways To Use

Versatile

As Inner Bag



SERIES HIGHLIGHTS

- Designed to keep your camera gear safe in any backpack or roller bag
- Next generation dividers with multi-folding styles
- Front access to full kit, with quick top access
- Converts to a shoulder bag, with a simple backpack mode option
- Lightweight, water resistant material
- Trolley sleeve (except F27)

MODEL	INTERIOR DIMENSIONS (INCHES MM)	EXTERIOR DIMENSIONS (INCHES MM)	MAX LOAD (LBS KG)	WEIGHT (LBS KG)	FITS DEVICE	LITER SIZE (L)
VEO BIB F36	11.0 X 6.3 X 15.0 280 X 160 X 380	12.6 X 7.7 X 16.1 320 X 195 X 410	16.5 7.5	2.29 1.04	11" TABLET	17
VEO BIB F33	11.0 X 6.3 X 11.0 280 X 160 X 280	12.4 X 7.7 X 12.4 315 X 195 X 315	13.2 6	1.90 0.86	11" TABLET	13
VEO BIB F28	11.0 X 6.3 X 7.1 280 X 160 X 180	12.4 X 7.7 X 9.3 315 X 195 X 235	9.9 4.5	1.50 0.68	7" TABLET	8
VEO BIB F27	8.3 X 4.3 X 11.0 210 X 110 X 280	9.4 X 5.7 X 12.4 240 X 145 X 315	8.4 3.8	1.19 0.54	7" TABLET	6.5



VEO BIB DIVIDER S TOUGH BAG-IN-BAG FOR SUITCASES OR HOME STORAGE

The tough, water resistant outer shell on all the VEO BIB DIVIDER S Series is designed to keep valuable gear safe at home or on the go, while being easy to carry with a comfortable handle or padded shoulder strap. Alternatively it can be used with SUPREME hard case for the ultimate protection. Inside the slim, smart dividers can be tailored for your gear, and this doesn't need to be just for cameras and lenses. In addition there are multiple storage pockets for all the accessories you need, including up to a 15" laptop.



*Compatible with Supreme case series (Also Sold Separately)



*VEO BIB DIVIDER S53

Strong

Versatile



SERIES HIGHLIGHTS

- EVA moulded construction 1000D Polyester and metal frame for maximum protection
- Secure, waterproof zip closure
- Suitable for a pro DSLR/mirrorless camera and up to 18 lenses
- Pockets in the lid for up to a 15" laptop and documents
- Separate storage tray for a wealth of accessories such as SD cards and cables
- Padded handle and padded shoulder strap for carrying

MODEL	INTERIOR DIMENSIONS (INCHES MM)	EXTERIOR DIMENSIONS (INCHES MM)	MAX LOAD (LBS KG)	WEIGHT (LBS KG)	FITS DEVICE	LITER SIZE (L)
VEO BIB DIVIDER S53	21.1 X 6.9 X 15.7 535 X 175 X 400	22.0 X 8.7 X 17.1 560 X 220 X 435	29.8 13.5	6.70 3.04	15" LAPTOP	38
VEO BIB DIVIDER S46	17.5 X 6.9 X 12.8 445 X 175 X 325	18.9 X 8.5 X 14.0 480 X 215 X 355	24.2 11.0	5.33 2.42	13" LAPTOP	26
VEO BIB DIVIDER S40	15.6 X 5.9 X 9.6 395 X 150 X 245	17.1 X 7.5 X 10.8 435 X 190 X 275	19.2 8.7	3.92 1.78	11" TABLET	15
VEO BIB DIVIDER S37	13.6 X 5.9 X 8.1 345 X 150 X 205	15.4 X 7.5 X 9.8 390 X 190 X 250	13.7 6.2	3.13 1.42	7" TABLET	11

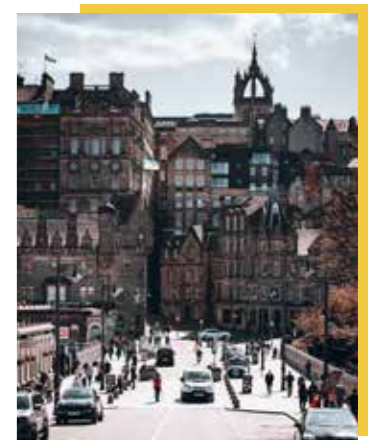

DIVIDER BAG

FOR SUPREME CASES OR HOME STORAGE

Vanguard Divider Bags are designed to fit inside Supreme Cases and offer ideal set-up for photo and video gear within the security of an infallible hard case.



*Compatible with Supreme case series(Also Sold Separately)



Photo/Video Equipment



Bird Watching Equipment



Precision Instruments

*DIVIDER BAG 53

Versatile



SERIES HIGHLIGHTS

- Padded storage bag to keep your gear safe in a Supreme Case, or safe at home when not needed
- Mesh pocket in the lid for accessories and documents
- Suitable for up to 16 pro bodies/lenses
- Padded handle for carrying



MODEL	INTERIOR DIMENSIONS [INCHES MM]	EXTERIOR DIMENSIONS [INCHES MM]	WEIGHT [LBS KG]	LITER SIZE [L]
DIVIDER BAG 53	21 X 15.8 X 6.9 535 X 400 X 175	22 X 16.8 X 7.9 560 X 425 X 200	3.64 1.65	-
DIVIDER BAG 46	17.5 X 12.9 X 6.9 445 X 325 X 175	18.8 X 13.7 X 7.6 480 X 345 X 195	3.00 1.34	-
DIVIDER BAG 40	15.5 X 9.6 X 5.9 395 X 245 X 150	17 X 10.9 X 6.8 430 X 275 X 170	1.98 0.90	-
DIVIDER BAG 37	13.7 X 8.1 X 5.9 345 X 205 X 150	15 X 9.8 X 6.8 380 X 240 X 170	1.65 0.75	-

SUPREME

WATERPROOF CASE



Virtually indestructible, the rugged Vanguard Supreme Series hard cases have innovative features for unmatched strength and durability. They are O-ring sealed, waterproof (up to a depth of 16.5 feet/5 meters), airtight, and built to withstand the most extreme conditions. Supreme cases are great for airline travel with an automatic pressure equalization valve. Anti-slip rubber feet and a solid carrying handle offer extra durability. Rest assured, your optics will be safe from all harm in these cases.



*SUPREME 53F



*SUPREME 53D



INCREDIBLY STRONG & RUGGED



WATER & DUST PROOF

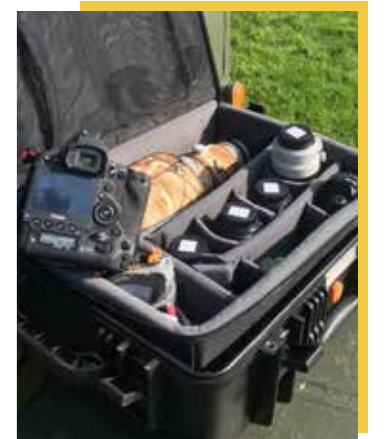

MODEL	INTERIOR DIMENSIONS [INCHES MM]	EXTERIOR DIMENSIONS [INCHES MM]	WEIGHT [LBS KG]
SUPREME 53F / SUPREME 53D	22 X 17.7 X 7.8 560 X 450 X 200	24.8 X 20.4 X 9.4 630 X 520 X 240	23 10.4
SUPREME 46F / SUPREME 46D	18.9 X 14.5 X 7.8 480 X 370 X 200	20.2 X 17.1 X 8.6 515 X 435 X 220	15 6.8
SUPREME 40F / SUPREME 40D	16.9 X 11.6 X 6.8 430 X 295 X 175	18.3 X 14.3 X 7.6 465 X 365 X 195	9.7 4.4
SUPREME 37F / SUPREME 37D	16.3 X 10.2 X 6.8 380 X 260 X 175	16.3 X 9.2 X 7.6 415 X 325 X 195	8.6 3.9
SUPREME 27F / SUPREME 27D	11 X 9.8 X 6.6 250 X 190 X 150	11 X 9.8 X 6.6 280 X 250 X 170	4.19 1.9

VESTA ASPIRE BACKPACKS/SHOULDER BAGS

The new Vesta Aspire Collection by Vanguard has set its goal to become the 'go-to' accessory choice of new photographers engaging for the first time in the passionate world of image making. To do this our collection goals were simple; our accessories must share the passion, while offering a seamless intuitive user experience that will become part of everyday life alongside the key star - the new camera! In this new series we guarantee the perfect first bag for anyone starting to engage passionately in photography. Designed for the most popular camera kits, Vesta Aspire delivers great protection, style and functionality in a range of perfectly fitted shoulder bags and backpack, all of which offer intuitive set-up and ease of use.



*VESTA ASPIRE 41 Backpacks



*VESTA ASPIRE 25/21/15
Shoulder bags



*VESTA ASPIRE 15Z
Shoulder bags



Backpacks

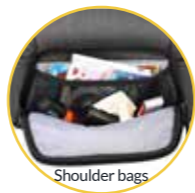

Shoulder bags



ASPIRE 15

Stay Steady

Backpacks Rear Opening

Shoulder Bags Opening

Ergonomic Design

SERIES HIGHLIGHTS

- Lightweight and Easy to Carry
- Extra Protective Sewing for better security
- Padded Comfortable Carrying Strap
- Smooth and durable zipper
- Divider Bag-Multifunction Cases

SHOULDER BAGS / BACKPACKS :

MODEL	INTERIOR DIMENSIONS (INCHES MM)	EXTERIOR DIMENSIONS (INCHES MM)	MAX LOAD (LBS KG)	WEIGHT (LBS KG)	FITS DEVICE	LITER SIZE (L)
VESTA ASPIRE 41	8.9 X 5.9 X 16.1 225 X 150 X 410	10 X 8.7 X 18.3 255 X 220 X 465	11.0 5	1.70 0.77	9.7" TABLET	-
VESTA ASPIRE 25	10.2 X 6.7 X 8.3 260 X 170 X 210	11.4 X 8.1 X 10 290 X 205 X 255	9.9 4.5	1.06 0.48	9" TABLET	-
VESTA ASPIRE 21	8.7 X 5.3 X 7.7 220 X 135 X 195	9.8 X 6.5 X 8.7 250 X 165 X 220	5.1 2.3	0.73 0.33	-	-
VESTA ASPIRE 15	6.3 X 4.5 X 5.9 160 X 115 X 150	7.0 X 5.9 X 7.9 180 X 150 X 200	3.3 1.5	0.48 0.22	-	-
VESTA ASPIRE 15Z	5.9 X 4.9 X 7.9 150 X 125 X 200	6.9 X 5.7 X 9.4 175 X 145 X 240	4.9 2.2	0.51 0.23	-	-



ALTA ACCESSORIES

Our photographers deserve the ultimate Alta Experience and a seamless workflow wherever their passion leads them. We offer them great products to enhance and support their passion not just when carrying their gear, but also when shooting in the field! Alta Accessories are part of our wide range of Alta Tripods and Bags and together they enable Vanguard to offer solutions for specific requirements such as quick action, element protection, gear organization, ergonomic comfort and much more!

ALTA BCS

Battery Case Small

Outside Dimensions:
105x35x115 mm | 4.1x1.3x4.5 in
Weight: 0.09 lbs | 0.04 kg



ALTA BCL

Battery Case Large

Outside Dimensions:
190x35x115 mm | 7.5x1.3x4.5 in
Weight: 0.16 lbs | 0.07 kg



ALTA RC Rain Cape

The Alta Rain Cape is an ingenious shooting in the rain solution designed to protect your camera and lens from the elements. This multi-use cover folds into a compact pouch and easily fits in any bag, so that you are never caught out in a downpour without adequate protection.



ALTA RCS

Outside Dimensions:
510x600 mm | 20.1x23.6 in
Weight: 0.19 lbs | 0.08kg
Camera lens:
24-70mm/18/135mm F2.8



ALTA RCM

Outside Dimensions:
600x600 mm | 23.6x23.6 in
Weight: 0.19 lbs | 0.08kg
Camera lens:
70-200mm



ALTA RCL

Outside Dimensions:
860x950 mm | 34x37.3 in
Weight: 0.29 lbs | 0.12kg
Camera lens:
~400mm



ALTA RCXL

Outside Dimensions:
970x950 mm | 38.3x37.3 in
Weight: 0.29 lbs | 0.12kg
Camera lens:
~600mm

ALTA SBM

Stone Bag Medium

Exterior dimension:
355x350 mm | 14 x 13.7 in
Expanding strap: 180 mm | 7.2 in
Max leg-to-leg distance:
680 mm | 26.7 in
Max loading: 20 kg | 44 lbs
Max leg diameter: <40 mm



ALTA SBL

Stone Bag Large

Exterior dimension:
355x350 mm | 14 x 13.7 in
Expanding strap: 220 mm | 8.6 in
Max leg-to-leg distance: 760 mm | 30 in
Max loading: 30 kg | 66 lbs
Max leg diameter: <45 mm



• Stabilize any tripod by providing a centralized, balanced weight

• Stabilize any tripod by providing a centralized, balanced weight

ALTA ACTION

The Alta Action advanced carrying tripod bags are tailored to best fit and protect our Alta Pro tripods & heads. More than just a great tripod carrying solution these bags are designed to support the full Alta experience.



MODEL	INTERIOR DIMENSIONS (INCHES MM)	EXTERIOR DIMENSIONS (INCHES MM)	MAX LOAD (LBS KG)	WEIGHT (LBS KG)
ALTA ACTION 80	31.5 X 6.7 X 5.1 800 X 170 X 130	32.1 X 7.1 X 5.5 815 X 180 X 140	8.8 4.0	0.84 0.38
ALTA ACTION 70	27.5 X 6.7 X 5.1 700 X 170 X 130	28.1 X 7.1 X 5.5 715 X 180 X 140	7.7 3.5	0.77 0.35
ALTA ACTION 60	23.6 X 5.5 X 3.8 600 X 140 X 100	24.2 X 5.8 X 4.3 615 X 150 X 110	6.6 3	0.66 0.30



Sporting Optics

Since 1986, VANGUARD has been a part of the worldwide photo/video market and launched new products every year. We have been recognized by well-known awards all over the world, have worked with creators from all walks of life, and have sold our products in more than 80 countries.

Vanguard optics belong to one of three main families: **The Endeavor series**, which boasts advanced features geared toward professionals; **the VEO series**, which offers advanced features for all types of users; and **the Vesta series**, our family of practical equipment designed for newcomers or those who just need a simple solution. Our collections include a wide range of binoculars, monoculars, spotting scopes, mounts, and other accessories.



 **ENDEAVOR**

 **VEO**

 **VESTA**

ENDEAVOR HD SPOTTING SCOPES

The angled view Endeavor HD spotting scope combines a nitrogen-filled magnesium housing and a fully multi-coated optical system to create a well equipped zoom scope for intermediate to long-range observation. The optical system employs Extra Low Dispersion (ED) Glass to ensure accurate color rendition and virtually eliminate color fringing. The lenses are fully multicoated to ensure optimum light transmission and feature a phase-coated BAK4 roof prism. It also provides a very impressive field of view. In addition to the image quality and weather-sealed construction, the Endeavor HD includes several features that enhance the scope's functionality. It features an extendable rubber covered eyecup and boasts impressive eye relief even at the highest zoom settings. A built-in sunshield is included to eliminate glare in direct sunlight and it includes a padded raincoat with sling for carry and protection. Endeavor HD is also equipped with rapid focus and fine focus wheels for quick and precision fine tuning adjustments. The Endeavor HD mounts directly to Vanguard tripod heads (and others) that are equipped with the universal mounting plate without the use of a quick shoe.



* ENDEAVOR HD 82A



Easy Body Rotation



Removable Eyepiece



Custom Fit Rain Cover

PERFECT PARTNERS

Endeavor HD 82A [P76]
VEO PA-65 [P90]
VEO 3 263AO [P22]



SERIES HIGHLIGHTS

- Premium ED glass assures exceptional detail and brilliant colors
- Advanced MultiGuard® coatings for higher light transmittance
- Modern ergonomics with rubber armored magnesium
- Stacked, dual-focus controls for making quick and fine adjustments
- Dual Focus Controls For FineTuning Adjustments
- Built-In Sunshield Eliminates Glare in Direct sunlight
- Extra-Low Dispersion Glass
- Arca Swiss Compatible Mountable to Tripod

MODEL	POWER	OBJECTIVE LENS (MM)	FIELD OF VIEW (FT/1000 YDS M/1000 M)	NEAR FOCUS (FEET M)	EYE RELIEF (MM)	WEIGHT (OZ G)
ENDEAVOR HD 82A	20-60 X	82	110-52 37-17	19.7-21.3 6-6.5	19-20	63.85 1810
ENDEAVOR HD 65A	15-45 X	65	144-68 48-23	14.8-18 4.5-5.5	19-20	51.15 1450

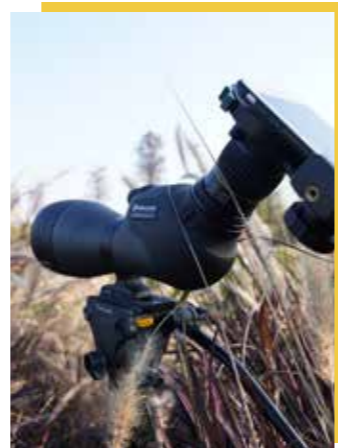

ENDEAVOR XF SPOTTING SCOPES

The Endeavor XF spotting scope boasts excellent optical viewing for nature enthusiasts and hunters. It features a rubber armored magnesium body and is waterproof submersible, nitrogen filled, and fogproof. The lenses are all fully multicoated to ensure optimum light transmission and feature a phasecoated BAK4. The Endeavor XF 60A comes with a 60mm objective lens and angled eyepiece with 15-45x zoom magnification. It features an extendable rubber covered eyecup and boasts impressive eye relief even at the highest zoom settings. It also provides a very impressive field of view. A built-in sunshield is included to eliminate glare in direct sunlight and it includes a padded raincoat with a sling for carrying and protection. Endeavor XF is equipped with a large smooth focusing wheel for quick focusing adjustments. The Endeavor XF mounts directly to Vanguard tripod heads (and others) that are equipped with the universal mounting plate without the use of a quick shoe. The tripod mount on the angled scope rotates to give optimum viewing angles in a variety of situations such as bench shooting and use with a window mount.



* ENDEAVOR XF 80A



Easy Body Rotation

PERFECT PARTNERS

Endeavor XF 80A [P77]
VEO PA-65 [P90]
VEO 3 263CO [P22]



SERIES HIGHLIGHTS

- Angled Eyepiece With 15-45X Zoom Magnification
- Large Focus Wheel for Easy Use, Even with Gloves
- Fully Multi-Coated Optics and PhaseCoated BAK4 Prism
- Rubber Armored Magnesium Body
- 4 layers Coatings
- Built-In Lens Cap
- Tripod Mounting Shoe

MODEL	POWER	OBJECTIVE LENS (MM)	FIELD OF VIEW (FT/1000 YDS M/1000 M)	NEAR FOCUS (FEET M)	EYE RELIEF (MM)	WEIGHT (OZ G)
ENDEAVOR XF 80A	20-60 X	80	110-52 37-17	19.7-21.3 6-6.5	19-20	59.3 1680
ENDEAVOR XF 60A	15-45 X	60	141-68 47-23	16.4-19.7 5-6	19-20	45.1 1280



VEO HD SPOTTING SCOPES

The VEO HD spotting scope boasts excellent optical viewing for nature enthusiasts. It is nitrogen-filled, making it waterproof/fogproof for challenging weather conditions. The lenses are all fully multi-coated to ensure optimum light transmission, and each scope is equipped with a large, smooth focusing wheel for quick adjustments. The lightweight and durable carbon-composite body is well-balanced, so whether in the field or at the range, VEO HD is a must-have.



* VEO HD 80A



Twist out eyecup



Sun shield



Find The Most Comfortable Viewing Angle With 180° Rotatable Front Body

PERFECT PARTNERS

- VEO HD 80A [P78]
- VEO PA-65 [P90]
- VEO 3V 263AV16 [P14]



SERIES HIGHLIGHTS

- Up to 45x zoom with a choice of 50mm or 60mm objective lens
- BaK4 roof prism
- Fully Multi-Coated with Multiguard® 4
- Built in sunshield to eliminate glare in direct sunlight
- Waterproof, and nitrogen filled to be fogproof
- Arca compatible foot to fit into suitable clamp and eliminate movement
- Weighs as little as 1205g

MODEL	POWER	OBJECTIVE LENS [MM]	FIELD OF VIEW [FT/1000 YDS M/1000 M]	NEAR FOCUS [FEET M]	EYE RELIEF [MM]	WEIGHT [OZ G]
VEO HD 80A	20-60X	80	110-52 37-17	19.7-21.3 6-6.5	19-20	54.7 1550
VEO HD 60A	15-45X	60	141-68 47-23	16.4-19.7 5-6	19-20	42.5 1205



VESTA SPOTTING SCOPE KITS

The VESTA series of spotting scopes is recommended for anyone starting out with a spotting scope, or looking for something smaller to carry with ease. To the benefit of outdoor enthusiasts these scopes are compatible with many sized tripods. The Vesta 350 and 460 models are small enough to fit in the side pocket of a backpack and work great on a table top. Travelers and trend setters worldwide will also appreciate the Vanguard Vesta optics which are loaded with quality and deliver excellent value.



* VESTA 560A



VESTA 350A



VESTA 460A

PERFECT PARTNERS

- VESTA 350A [P79]
- VEO PA-65 [P90]
- VESTA 203AP [P23]



Model No:560A comes with VS-82 Tabletop Tripod



Model No:350A and 460A comes with Vesta TT1 Table Tripod

SERIES HIGHLIGHTS

- Up to 60x zoom with a choice of 60mm or 80mm objective lens
- Extra Low (ED) Dispersion Glass
- BaK4 roof prism
- Fully Multi-Coated with Multiguard® 4
- Waterproof, and nitrogen filled to be fogproof
- Weighs as little as 600g

MODEL	POWER	OBJECTIVE LENS [MM]	FIELD OF VIEW [FT/1000 YDS M/1000 M]	NEAR FOCUS [FEET M]	EYE RELIEF [MM]	WEIGHT [OZ G]
VESTA 560A	15-45X	60	34.8 - 20.9 10.44 - 6.26	8 - 9 26.3 - 29.5	16-21	45.7 1293
VESTA 460A	15-50X	60	41.7 - 19.1 12.5 - 5.74	10 - 12 32.8 - 39.4	11	21.5 609
VESTA 350A	12-45X	50	52.2 - 17.4 15.6 - 5.22	9 - 12 29.5 - 39.4	11	21.2 600

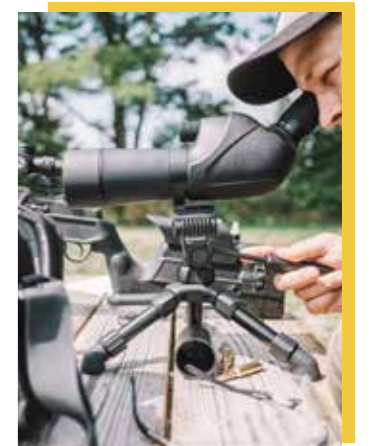

VEO HD IV BINOCULARS

Vanguard's new VEO HD IV binocular series offers an upgraded viewing experience for nature lovers, birders, sports fans, and travelers. The innovative pairing of Premium HOYA ED (Extra-low Dispersion) glass and SK-15 prisms produces crystal-clear images of your subject while preserving its true image and color integrity.



* VEO HD IV 1042

PERFECT PARTNERS

- VEO HD IV 1042 [P80]
- VEO PA-62 [P90]
- BA-185 [P90]
- VEO 3T 204ABP [P24]

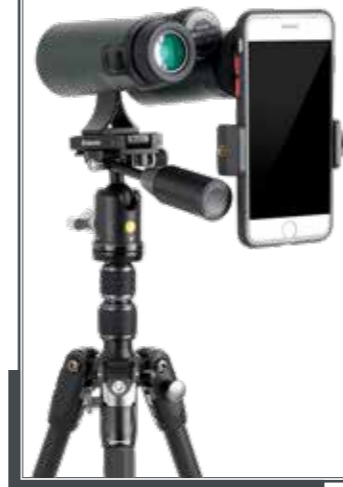

SERIES HIGHLIGHTS

- HOYA Extra Low (ED) Dispersion Glass
- SK-15 roof prism
- Fully Multi-Coated with Multiguard® 7
- Lockable dioptre
- Waterproof, and nitrogen filled to be fogproof
- Durable magnesium alloy housing
- Premium pebbled Mitsubishi rubber armour
- Tripod mountable (with adaptor such as the BA-185)
- Available as 8x42 and 10x42

MODEL	POWER	OBJECTIVE LENS (MM)	FIELD OF VIEW (FT/1000 YDS M/1000 M)	NEAR FOCUS (FEET M)	EYE RELIEF (MM)	ADJUST. PUPILLARY (MM)	WEIGHT (OZ G)
VEO HD IV 1042	10 X	42	340 114	5.9 1.8	19	56-74	277 786
VEO HD IV 8420	8 X	42	377 126	5.9 1.8	19	56-74	277 786



VEO HD 2 BINOCULARS

The VEO HD2 Binocular features HOYA extra-low dispersion (ED) glass and phase-corrected BAK4 prisms that work together to virtually eliminate chromatic aberration and produce images with true color fidelity across the entire field of view and enhanced contrast. Complementing the glass and prisms are an anti-reflective and fully multi-coated optical system that improves light transmission for bright and clear images with greater low-light performance.



* VEO HD2 1042

PERFECT PARTNERS

- VEO HD 2 1042 [P81]
- VEO PA-62 [P90]
- BA-185 [P90]
- VEO 2SAM-234TBP50T [P33]



SERIES HIGHLIGHTS

- HOYA Extra Low (ED) Dispersion Glass
- Phase corrected Bak4 roof prisms
- Fully Multi-Coated with Multiguard® 7
- Lockable dioptre
- Waterproof, and nitrogen filled to be fogproof
- Lightweight carbon composite housing
- Premium Mitsubishi rubber armour
- Tripod mountable (with adaptor such as the BA-185)
- Available as 8x42 and 10x42

MODEL	POWER	OBJECTIVE LENS (MM)	FIELD OF VIEW (FT/1000 YDS M/1000 M)	NEAR FOCUS (FEET M)	EYE RELIEF (MM)	ADJUST. PUPILLARY (MM)	WEIGHT (OZ G)
VEO HD2 1042	10 X	42	340 114	6.6 2.0	18	58-74	25 710
VEO HD2 8420	8 X	42	377 126	6.6 2.0	19	58-74	25 710



VEO HD BINOCULARS

The VEO HD Binocular features extra-low dispersion (ED) glass and phase-corrected BAK4 prisms that work together to virtually eliminate chromatic aberration and produce images with true color fidelity across the entire field of view and enhanced contrast. Complementing the glass and prisms are an anti-reflective and fully multi-coated optical system that improves light transmission for bright and clear images with greater low-light performance.



* VEO HD 1042

PERFECT PARTNERS

VEO OPTIC GUARD H DLX [P91]



Silicon(GR)



Leather(BR)



SERIES HIGHLIGHTS

- Extra Low (ED) Dispersion Glass
- Phase corrected Bak4 roof prisms
- Fully Multi-Coated with Multiguard® 7
- Lockable dioptre
- Waterproof, and nitrogen filled to be fogproof
- Lightweight carbon composite housing
- Premium Mitsubishi moulded rubber armour
- Tripod mountable (with adaptor such as the BA-185)
- Available as 8x42 and 10x42

MODEL	POWER	OBJECTIVE LENS (MM)	FIELD OF VIEW (FT/1000 YDS M/1000 M)	NEAR FOCUS (FEET M)	EYE RELIEF (MM)	ADJUST. PUPILLARY (MM)	WEIGHT (OZ G)
VEO HD 1042	10 X	42	342 114	6.6 2.0	18	58-74	27.1 767
VEO HD 8420	8 X	42	372 124	6.6 2.0	19	58-74	26.8 760



VEO ED BINOCULARS

VEO ED is a well-balanced, lightweight, and durable carbon-composite binocular. It is 100% waterproof/fogproof, and designed to take on challenging weather conditions. Extra Low Dispersion (ED) Glass effectively reduces chromatic aberration and enhances color resolution and contrast. The VEO ED is essential for every outdoor enthusiast.



* VEO ED 1250

PERFECT PARTNERS

VEO OPTIC GUARD H [P91]



Silicon(BK)

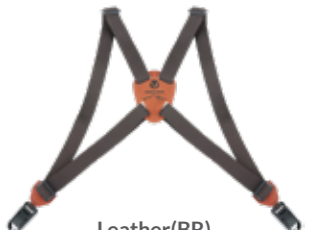

Leather(BR)



SERIES HIGHLIGHTS

- Super light, weighing from just 640g/23oz
- Extra Low (ED) Dispersion Glass
- Phase corrected Bak4 roof prisms
- Fully Multi-Coated with Multiguard® 4
- Waterproof, and nitrogen filled to be fogproof
- Lightweight carbon composite housing
- Premium Mitsubishi textured rubber armour
- Tripod mountable (with adaptor such as the BA-185)
- Available as 8x42, 10x42, 10x50 and 12x50

MODEL	POWER	OBJECTIVE LENS (MM)	FIELD OF VIEW (FT/1000 YDS M/1000 M)	NEAR FOCUS (FEET M)	EYE RELIEF (MM)	ADJUST. PUPILLARY (MM)	WEIGHT (OZ G)
VEO ED 1250	12 X	50	251 84	11.5 3.5	18	60-75	26.8 760
VEO ED 1250	10 X	50	282 94	9.8 3	19	59.5-75	27.6 782
VEO ED 1042	10 X	42	314 105	9.2 2.8	16	55-75	22.6 640
VEO ED 8420	8 X	42	330 110	8.2 2.5	19	55-75	22.6 640



VEO XF BINOCULARS

VEO XF offers outstanding image quality and user-friendly features. All nature enthusiasts will enjoy the fully multi-coated, bright, high-resolution optics that are built into a textured rubber armor, waterproof, fogproof body that will hold up to any challenging weather.



* VEO XF



PERFECT PARTNERS

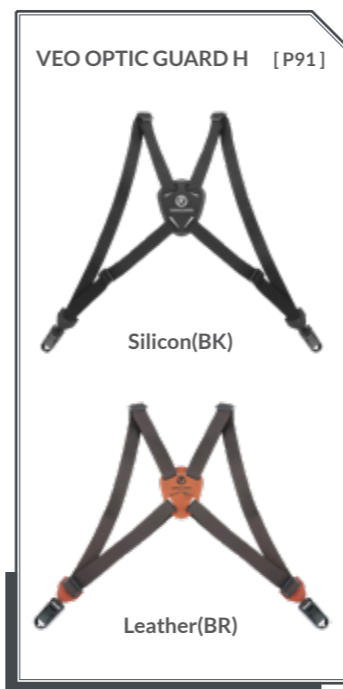

SERIES HIGHLIGHTS

- Super light, weighing from just 640g/23oz
- Premium Optical Glass
- Phase corrected Bak4 roof prisms
- Fully Multi-Coated with Multiguard® 4 - how many layers
- Waterproof, and nitrogen filled to be fogproof
- Premium Mitsubishi textured rubber armour
- Tripod mountable (with adaptor such as the BA-185)
- Available as 8x42 and 10x42

MODEL	POWER	OBJECTIVE LENS (MM)	FIELD OF VIEW (FT/1000 YDS M/1000 M)	NEAR FOCUS (FEET M)	EYE RELIEF (MM)	ADJUST. PUPILLARY (MM)	WEIGHT (OZ G)
NEW VEO XF 1042	10 X	42	332 111	6.9 2.1	16	57-74	22.6 640
NEW VEO XF 8420	8 X	42	409 136	6.9 2.1	20	57-74	23.3 660



VESTA BINOCULARS

The Vesta 25mm & 42mm binoculars cater to nature lovers worldwide who are looking for a high performing and mechanically solid binocular with excellent value. The Vesta series binoculars are sharp looking with a stylish European design that are low in weight and high in performance. Assembled with light weight housing material and rubber armoring for added no slip security that surrounds optical quality glass and coatings. Enhancing BAK4 roof prism system combined with Multiguard® multi-coating technology deliver surprising resolution, clarity, color fidelity and light transmission. Twist eye cups and a customized right eye diopter adjustment perfectly match the environment and the application. Vesta 25mm & 42mm binoculars are waterproof and fogproof.



* VESTA 8420



PERFECT PARTNERS



SERIES HIGHLIGHTS

- Perfect starter binoculars
- Super light, weighing from just 280g/10oz
- Phase corrected Bak4 roof prisms (BK7 in 8x25 and 10x25)
- Fully Multi-Coated
- Waterproof, and nitrogen filled to be fogproof
- Rubber armour
- Tripod mountable (with adaptor such as the BA-185)
- Available as 8x25, 8x42, 10x25 and 10x42

MODEL	POWER	OBJECTIVE LENS (MM)	FIELD OF VIEW (FT/1000 YDS M/1000 M)	NEAR FOCUS (FEET M)	EYE RELIEF (MM)	ADJUST. PUPILLARY (MM)	WEIGHT (OZ G)
VESTA 1042	10 X	42	298 100	6.9 2.1	17	56-74	20.8 590
VESTA 8420	8 X	42	325 108	6.9 2.1	19	56-74	21.5 610
VESTA 1025	10 X	25	330 110	8.2 2.5	10	56-74	9.88 280
VESTA 8250	8 X	25	340 114	8.2 2.5	12.5	56-74	9.88 280

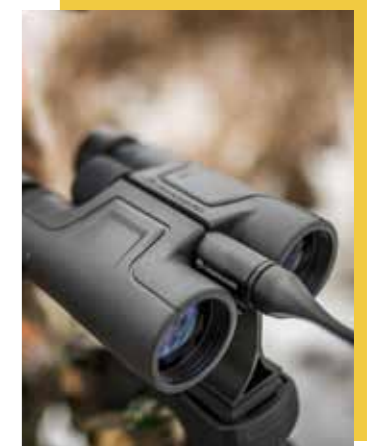

VESTA COMPACT BINOCULARS

The Vesta Compact 21 caters to nature lovers worldwide who are looking for a fun and care free optic with excellent value. The Vesta Compact 21 is a sharp looking and stylish carry along that is light in weight and high in performance. Assembled with lightweight materials, containing optical quality glass and coatings for surprising clarity and color fidelity.



* VESTA 8210 ROSE



Available in 4 Color options



Includes neck strap and pouch



SERIES HIGHLIGHTS

- Ergonomic and durable body with a slim, sleek profile
- Lightweight yet durable aluminum housing
- Roof prism design and coated lenses for a clear viewing experience
- Fast and smooth center focus wheel for ease of use
- Twist out and lockable rubber eyecups for comfortable viewing

MODEL	POWER	OBJECTIVE LENS (MM)	FIELD OF VIEW (FT/1000 YDS M/1000 M)	NEAR FOCUS (FEET M)	EYE RELIEF (MM)	ADJUST. PUPILLARY (MM)	WEIGHT (OZ G)
VESTA 8210	8 X	21	123.5 370.6	4 13.2	10	56.5-72	6.88 195
VESTA 1021	10 X	21	100.9 302.7	4 13.2	8	56.5-72	6.88 195



VEO HD 2 1042M MONOCULAR

The VEO HD2 Monocular features HOYA extra-low dispersion (ED) glass to virtually eliminate chromatic aberration and produce images with true color fidelity across the entire field of view and enhanced contrast. The package includes a smartphone adapter and bluetooth remote so you can capture crisp, clear images on the go



* VEO HD 2 1042M

PERFECT PARTNERS

VEO OPTIC GUARD WS [P91]



BK

BR

WHAT'S INCLUDED



Smartphone Adapter for up to 6.3 Inches

Bluetooth Remote Control for IOS/ Android



SERIES HIGHLIGHTS

- HOYA Extra Low (ED) Dispersion Glass
- Phase corrected Bak4 roof prisms
- Fully Multi-Coated with Multiguard® 7
- Ergonomic central focus wheel
- Waterproof, and nitrogen filled to be fogproof
- Tripod mountable using 1/4" thread on base
- Includes smartphone digiscope adaptor
- Includes Bluetooth remote control for IOS and Android
- Weighs just 325g and small enough to fit into a pocket

MODEL	POWER	OBJECTIVE LENS (MM)	FIELD OF VIEW (FT/1000 YDS M/1000 M)	NEAR FOCUS (FEET M)	EYE RELIEF (MM)	WEIGHT (OZ G)
VEO HD 2 1042M	10 X	42	342 114	6.5 2.0	18	11.5 325



VEO ED 8420M MONOCULAR

Vanguard's new VEO ED 8420M monocular offers a new, compact way for you to get a closer look in the field or at events. This 100% waterproof and fogproof optics piece features Extra-Low Dispersion (ED) Glass, which effectively reduces chromatic aberration and enhances color resolution and contrast. The package includes VEO PA-62 smartphone adapter and Bluetooth remote, so you can capture your magnified subjects on film or video.



*VEO ED 8420M

PERFECT PARTNERS



WHAT'S INCLUDED



Smartphone Adapter for up to 6.3 Inches

Bluetooth Remote Control for IOS/Android



SERIES HIGHLIGHTS

- Extra Low (ED) Dispersion Glass
- Phase corrected Bak4 roof prisms
- Fully Multi-Coated with Multiguard® 4
- Ergonomic central focus wheel
- Waterproof, and nitrogen filled to be fogproof
- Tripod mountable using 1/4" thread on base
- Includes smartphone digiscope adaptor
- Includes Bluetooth remote control for IOS and Android
- Weighs just 300g and small enough to fit into a pocket

MODEL	POWER	OBJECTIVE LENS (MM)	FIELD OF VIEW (FT/1000 YDS M/1000 M)	NEAR FOCUS (FEET M)	EYE RELIEF (MM)	WEIGHT (OZ G)
VEO ED 8420M	8X	42	324 108	8.2 2.5	19	10.6 300



VESTA 8320M MONOCULAR

The Vanguard Vesta 8320M monocular delivers optimal optical performance in a lightweight and compact body. The package includes a smartphone adapter and Bluetooth remote so you can capture crisp, clear images on the go.



*VESTA 8320M

PERFECT PARTNERS



WHAT'S INCLUDED



Smartphone Adapter for up to 6.3 Inches

Bluetooth Remote Control for IOS/Android



SERIES HIGHLIGHTS

- Phase corrected BaK4 roof prism
- Fully Multi-Coated
- Ergonomic central focus wheel
- Waterproof, and nitrogen filled to be fogproof
- Tripod mountable using 1/4" thread on base
- Includes smartphone digiscope adaptor
- Includes Bluetooth remote control for IOS and Android
- Weighs just 120g and small enough to fit into a pocket

MODEL	POWER	OBJECTIVE LENS (MM)	FIELD OF VIEW (FT/1000 YDS M/1000 M)	NEAR FOCUS (FEET M)	EYE RELIEF (MM)	WEIGHT (OZ G)
VESTA 8320M	8X	32	393.2 131	6.56 2.0	17.7	9.24 262



OPTICS ACCESSORIES CAPTURE SIGHTINGS WITH YOUR SMARTPHONE

VEO PA-65

Universal Smartphone Adaptor for most Spotting Scopes

VEO PA-65 is a universal smartphone digiscoping kit that will fit any smartphone up to 3.54inches/90mm wide, and can be used with almost any spotting scope from any brand to enable you to take captivating closeup shots and share them straight to social media

Fits smartphones up to: 59-90mm/2.3-3.5in.wide
Fits eye pieces between: Ø34-54mm/1.3-2.1in.



BA-185

Binocular Tripod Adaptor

The BA-185 Binocular Tripod Adapter steadies a binocular for clear, relaxed, hands-free viewing. It works with any roof prism binocular that has a standard 1/4-20 thread tripod socket, and on most models its thin bridge will still allow you to set your binocular to the minimum interpupillary distance adjustment



VEO PA-62

Universal Smartphone Adaptor for most Binoculars

VEO PA-62 universal digiscope adaptor can be used for taking photos or video with almost any smartphone up to 91mm/3.6 inches wide, with an adjustable arm that can be aligned to any lens on the camera. It quickly attaches to the eyepiece of any binocular or monocular that has a diameter between 41.5-44.7mm/1.6-1.8 inches wide, and can be paired to Apple or Android smartphones with the included Bluetooth remote for touch-free control.

Fits smartphones up to: 60-91mm/2.4-3.6in.wide
Fits eye pieces between: Ø41.5-44.7mm/1.6-1.8in



PA-202

Spotting Scope Camera Adaptor

PA-202 is a digiscoping adaptor designed specifically to fit Endeavor HD Spotting Scopes and allow any camera with a 52/58mm lens to be attached securely



VEO OPTIC GUARD QUICK RELEASE INTERCHANGEABLE HARNESS SYSTEM

The VEO OPTIC GUARD series is the quintessential harness solution for passionate birders who use their binoculars or cameras for extended periods. The Optic Guard is designed with ultimate ergonomic comfort in mind, enabling you carry your gear in the field without added weight or pressure. Whether you're just heading out for a short hike or committed to a long-term birding experience, the VEO OPTIC GUARD series is sure to enhance your outdoor experience

VEO OPTIC GUARD H DLX



VEO OPTIC GUARD H



VEO OPTIC GUARD NS



VEO OPTIC GUARD WS



MODEL	STRAP LENGTH (INCHES MM)	STRAPWIDTH (INCHES MM)	MAXLOAD (LBS KG)	WEIGHT (LBS G)
VEO OPTIC GUARD H DLX	-	1.0 25	5.5 2.5	0.53 240
VEO OPTIC GUARD H	-	1.0 25	2.2 1.0	0.31 140
VEO OPTIC GUARD NS	33-43 838-1092	1.0 25	5.5 2.5	0.26 120
VEO OPTIC GUARD WS	-	1.0 25	4.0 1.8	0.09 40



TRIPODS

MODEL	FOLDED HEIGHT [INCHES MM]	EXTENDED HEIGHT [INCHES MM]	MINIMUM HEIGHT [INCHES MM]	LEG DIAMETER [MM]	LEG SECTIONS	HEAD	MAX LOAD [LBS KG]	WEIGHT [LBS KG]	LEG MATERIAL
ALTA PRO 3VRL 303AT	29.88 759	66.93 / 1700	7.09 / 180	30	3	-	55.1 25	5.38 2.44	ALUMINUM ALLOY
ALTA PRO 3VRL 303CT	29.88 759	66.93 / 1700	7.09 / 180	30	3	-	55.1 25	4.60 2.09	CARBON FIBER
ALTA PRO 3VRL 303AV20	33.90 861	70.94 / 1802	11.10 / 282	30	3	VEO PV-20	13.2 6	8.00 3.63	ALUMINUM ALLOY
ALTA PRO 3VRL 303CV20	33.90 861	70.94 / 1802	11.10 / 282	30	3	VEO PV-20	13.2 6	7.21 3.27	CARBON FIBER
ALTA PRO 3VRL 303AV18	34.02 864	71.06 / 1805	11.22 / 285	30	3	VEO PV-18	33.1 15	7.98 3.62	ALUMINUM ALLOY
ALTA PRO 3VRL 303CV18	34.02 864	71.06 / 1805	11.22 / 285	30	3	VEO PV-18	33.1 15	7.19 3.26	CARBON FIBER
ALTA PRO 3VL 303AV20	33.54 852	70.87 / 1800	11.02 / 280	30	3	VEO PV-20	13.2 6	8.22 3.73	ALUMINUM ALLOY
ALTA PRO 3VL 303CV20	33.54 852	70.87 / 1800	11.02 / 280	30	3	VEO PV-20	13.2 6	7.43 3.37	CARBON FIBER
ALTA PRO 3VL 303AV18	33.66 855	70.87 / 1800	11.22 / 285	30	3	VEO PV-18	33.1 15	8.20 3.72	ALUMINUM ALLOY
ALTA PRO 3VL 303CV18	33.66 855	70.87 / 1800	11.22 / 285	30	3	VEO PV-18	33.1 15	7.41 3.36	CARBON FIBER
ALTA PRO 3VL 263AV16	32.28 820	67.13 / 1705	7.28 / 185	26	3	VEO PV-16	22.0 10	6.72 3.05	ALUMINUM ALLOY
ALTA PRO 3VL 263CV16	32.28 820	67.13 / 1705	7.28 / 185	26	3	VEO PV-16	22.0 10	5.94 2.69	CARBON FIBER
VEO 3V 303AV18	28.94 735	71.06 / 1805	10.04 / 255	30	3	VEO PV-18	33.1 15	6.67 3.03	ALUMINUM ALLOY
VEO 3V 303CV18	28.94 735	71.06 / 1810	10.04 / 255	30	3	VEO PV-18	33.1 15	5.96 2.71	CARBON FIBER
VEO 3V 263AV16	28.74 730	70.47 / 1790	8.94 / 227	26	3	VEO PV-16	22.0 10	5.91 2.68	ALUMINUM ALLOY
VEO 3V 263CV16	28.74 722	70.47 / 1810	8.94 / 247	26	3	VEO PV-16	22.0 10	5.29 2.40	CARBON FIBER
VEO3+303ABS	31.14 791	69.84 1774	8.46 215	30	3	VEO BH-250S	55.1 25	6.47 2.94	ALUMINUM ALLOY
VEO3+303CBS	31.14 791	69.84 1774	8.46 215	30	3	VEO BH-250S	55.1 25	5.70 2.59	CARBON FIBER
VEO3+303AT	26.38 670	65.08 1653	8.46 215	30	3	-	44.1 20	5.05 2.29	ALUMINUM ALLOY
VEO3+303CT	26.38 670	65.08 1653	8.46 215	30	3	-	44.1 20	4.29 1.95	CARBON FIBER
VEO3+263ABI60S	30.47 774	68.46 1739	4.92 125	26	3	VEO BH-160S	33.1 15	5.50 2.50	ALUMINUM ALLOY
VEO3+263CBI60S	30.47 774	68.46 1739	4.92 125	26	3	VEO BH-160S	33.1 15	4.79 2.17	CARBON FIBER
VEO3+263APS	30.71 780	68.31 1735	8.66 220	26	3	VEO PH-38S	22.0 10	5.96 2.71	ALUMINUM ALLOY
VEO3+263CPS	30.71 780	68.31 1735	8.66 220	26	3	VEO PH-38S	22.0 10	5.12 2.32	CARBON FIBER
VEO3+263AT	26.10 663	64.09 1628	4.92 125	26	3	-	33.1 15	4.42 2.01	ALUMINUM ALLOY
VEO3+263CT	26.10 663	64.09 1628	4.92 125	26	3	-	33.1 15	3.71 1.68	CARBON FIBER
VEO3T+264AB	18.9 480	61.42 1560	6.69 170	26	4	VEO BH-160S	33.1 15	5.41 2.45	ALUMINUM ALLOY
VEO3T+264CB	18.9 480	61.42 1560	6.69 170	26	4	VEO BH-160S	33.1 15	5.01 2.27	CARBON FIBER
VEO3T+234AB	18.11 460	57.48 1460	6.61 168	23	4	VEO BH-110S	22.0 10	4.83 2.19	ALUMINUM ALLOY
VEO3T+234CB	18.11 460	57.48 1460	6.61 168	23	4	VEO BH-110S	22.0 10	4.36 1.98	CARBON FIBER
VEO3T+264APS	18.9 480	61.30 1557	8.19 208	26	4	VEO PH-38S	22.0 10	5.84 2.65	ALUMINUM ALLOY
VEO3T+264CPS	18.9 480	61.30 1557	8.19 208	26	4	VEO PH-38S	22.0 10	5.34 2.43	CARBON FIBER
VEO3T+234APS	18.03 458	57.48 1460	7.99 203	23	4	VEO PH-36S	13.2 6	5.09 2.31	ALUMINUM ALLOY
VEO3T+234CPS	18.03 458	57.48 1460	7.99 203	23	4	VEO PH-36S	13.2 6	4.66 2.12	CARBON FIBER
VEO3T+264AT	18.9 480	57.09 1450	6.69 170	26	4	-	33.1 15	4.33 1.96	ALUMINUM ALLOY
VEO3T+264CT	18.9 480	57.09 1450	6.69 170	26	4	-	33.1 15	3.93 1.78	CARBON FIBER
VEO3 303AB	29.3 745	72.1 1831	10.5 266	30	3	VEO BH-250S	55.1 25	5.70 2.59	ALUMINUM ALLOY
VEO3 303CB	29.3 745	72.1 1831	10.5 266	30	3	VEO BH-250S	55.1 25	4.93 2.24	CARBON FIBER
VEO3 263AB	29.1 738	70.7 1795	10.4 265	26	3	VEO BH-160S	33.1 15	4.72 2.14	ALUMINUM ALLOY
VEO3 263CB	29.1 738	70.7 1795	10.4 265	26	3	VEO BH-160S	33.1 15	4.19 1.90	CARBON FIBER
VEO3 303APS	28.9 735	71.7 1821	10.2 259	30	3	VEO PH-38S	22.0 10	5.70 2.59	ALUMINUM ALLOY
VEO3 303CPS	28.9 735	71.7 1821	10.2 259	30	3	VEO PH-38S	22.0 10	4.94 2.24	CARBON FIBER
VEO3 263APS	29.1 738	70.6 1793	10.6 270	26	3	VEO PH-38S	22.0 10	5.11 2.32	ALUMINUM ALLOY
VEO3 263CPS	29.1 738	70.6 1793	10.6 270	26	3	VEO PH-38S	22.0 10	4.52 2.05	CARBON FIBER
VEO3 233APS	26.3 668	62.4 1585	9.5 240	23	3	VEO PH-36S	13.2 6	4.32 1.96	ALUMINUM ALLOY
VEO3 233CPS	26.3 668	62.4 1585	9.5 240	23	3	VEO PH-36S	13.2 6	3.88 1.76	CARBON FIBER
VEO3 263AO	27.9 708	69.4 1763	9.5 240	26	3	VEO PH-28	17.6 8	5.20 2.36	ALUMINUM ALLOY
VEO3 263CO	27.9 708	69.4 1763	9.5 240	26	3	VEO PH-28	17.6 8	4.63 2.10	CARBON FIBER
VESTA 233AP	22.91 582	61.02 1550	21.69 551	23	3	PH-23	77 3.5	2.81 1.28	ALUMINUM ALLOY
VESTA 203AP	22.50 570	61.02 1550	21.06 535	20	3	PH-23	77 3.5	2.44 1.11	ALUMINUM ALLOY
VESTA 203AGH	22.50 570	61.02 1550	21.65 550	20	3	GH-45	77 3.5	2.47 1.12	ALUMINUM ALLOY
VESTA 204AP	20.50 520	61.02 1550	19.41 493	20	4	PH-23	77 3.5	2.49 1.13	ALUMINUM ALLOY

TRIPODS

MODEL	FOLDED HEIGHT [INCHES MM]	EXTENDED HEIGHT [INCHES MM]	MINIMUM HEIGHT [INCHES MM]	LEG DIAMETER [MM]	LEG SECTIONS	HEAD	MAX LOAD [LBS KG]	WEIGHT [LBS KG]	LEG MATERIAL
VEO3T 265HABP	17.3 439	65.4 1660	10.0 255	26	5	VEO BP-120T	26.5 12	4.7 2.11	ALUMINUM ALLOY
VEO3T 265HCBP	17.3 439	65.4 1660	10.0 255	26	5	VEO BP-120T	26.5 12	4.2 1.91	CARBON FIBER
VEO3T 235ABP	16.1 410	61.0 1550	9.4 240	23	5	VEO BP-50T	17.6 8	3.9 1.75	ALUMINUM ALLOY
VEO3T 235CBP	16.1 410	61.0 1550	9.4 240	23	5	VEO BP-50T	17.6 8	3.5 1.60	CARBON FIBER
VEO3T 204ABP	15.9 405	55.1 1400	8.9 225	20	4	VEO BP-45T	8.8 4	3.3 1.49	ALUMINUM ALLOY
VEO3T 204CBP	15.9 405	55.1 1400	8.9 225	20	4	VEO BP-45T	8.8 4	3.0 1.38	CARBON FIBER
VEO 3G0 265HAB	16.14 410	65.55 1665	9.45 240	26	5	ALTA BH-102	22 10	3.66 1.66	ALUMINUM ALLOY
VEO 3G0 265HCB	16.14 410	65.55 1665	9.45 240	26	5	ALTA BH-102	22 10	3.12 1.42	CARBON FIBER
VEO 3G0 235AB	12.99 330	53.54 1360	7.87 200	23	5	T-50	11 5	2.70 1.23	ALUMINUM ALLOY
VEO 3G0 235CB	12.99 330	53.54 1360	7.87 200	23	5	T-50	11 5	2.34 1.07	CARBON FIBER
VEO 3G0 204AB	13.63 345	51.57 1310	12.99 330	20	4	T-45	6.6 3	2.08 0.95	ALUMINUM ALLOY
VEO 3G0 204CB	13.63 345	51.57 1310	12.99 330	20	4	T-45	6.6 3	1.80 0.82	CARBON FIBER
VESTA TB235AB	14.8 375	56.25 1430	10.63 270	23	5	T-51	9.9 4.5	2.65 1.20	ALUMINUM ALLOY
VESTA TB235CB	14.8 375	56.25 1430	10.63 270	23	5	T-51	9.9 4.5	2.27 1.03	CARBON FIBER
VESTA TB204AB	14.8 375	51.18 1300	12.01 305	20	4	T-46	6.6 3	2.06 0.93	ALUMINUM ALLOY
VESTA TB204CB	14.8 375	51.18 1300	12.01 305	20	4	T-46	6.6 3	1.77 0.80	CARBON FIBER
VEO3TT 233ABP	9.7 245	22.05 560	8.66 220	23	3	VEO BP-50T	17.6 8	2.56 1.16	ALUMINUM ALLOY
VEO3TT 233CBP	9.7 245	22.05 560	8.66 220	23	3	VEO BP-50T	17.6 8	2.43 1.10	CARBON FIBER
VEO3TT 203ABP	8.9 225	19.69 500	7.87 200	20	3	VEO BP-45T	8.8 4	2.15 0.98	ALUMINUM ALLOY
VESTA TTI	6.9 175	3.9 100	8.46 215	-	-	BALL HEAD	44 2	0.34 0.15	ALUMINUM ALLOY
VEO2SAM-234TBP50T	23.78 604	65.12 1654	23	4	VEO BP-50T	13.2 6	2.81 1.28	5.50 2.50	ALUMINUM ALLOY
VEO2SCM-264TBP120T	24.57 624	68.07 1729	26	4	VEO BP-120T	26.5 12	2.97 1.35	4.79 2.17	CARBON FIBER
VEO2SAM-264TR	21.50 545	64.13 1630	26	4	-	33.1 15	1.96 0.89	5.96 2.71	ALUMINUM ALLOY
VEO2SCM-264TR	21.50 545	64.13 1630	26	4	-	33.1 15	1.75 0.80	5.12 2.32	CARBON FIBER
VEO2SAM-234TR	20.50 520	61.00 1550	23	4	-	22 10	1.77 0.81	4.42 2.01	ALUMINUM ALLOY

HEADS

MODEL	LENGTH [INCHES MM]	WIDTH [INCHES MM]	HEIGHT [INCHES MM]	HEAD BASE [INCHES MM]	QUICK SHOE	FRONTAL TILT °	LATERAL TILT °	SWIVEL °	MAX LOAD [LBS KG]	WEIGHT [LBS KG]
VEO BH-250S	-	-	4.76 121	2.28 58	QS-62V3	-	-91°-35°	360	55 25	1.42 0.64
VEO BH-160S	-	-	4.37 111	2.28 58	QS-62V3	-	-91°-35°	360	33 15	1.07 0.49
VEO BH-110S	-	-	4.13 105	1.97 50	QS-62V3	-	-91°-35°	360	22 10	0.94 0.43
VEO BP-120T	-	3.82 97	4.23 107.5	1.85 47	QS-72T	-	-91°-35°	360	26.4 12	1.2 0.55
VEO BP-50T	-	3.07 78	3.9 99	1.73 44	QS-72T	-	-91°-40°	360	17.6 8	1.0 0.46
VEO BP-45T	-	2.68 68	3.5 89	1.65 42	QS-72T	-	-91°-35°	360	8.8 4	0.87 0.39
VEO PH-38S	8.27 210	7.09 180	4.41 112	2.28 58	QS-74	-91°-30°	-91°-30°	360°	22 10	1.42 0.64
VEO PH-36S	8.07 205	6.97 177	4.37 111	1.97 50	QS-74	-91°-30°	-91°-30°	360°	13.2 6	1.25 0.57
VEO PV-20	14.37 365	5.71 145	4.02 102	2.28 58	QS-67	-60°-90°	-	360°	13.2 6	2.62 1.19
VEO PV-18	15.94 405	6.02 153	4.13 105	2.28 58	QS-61P	-45°-90°	-	360°	33.1 15	2.60 1.18

ACCESSORY

MODEL	FULL EXTENDED HEIGHT [INCHES MM]	WEIGHT [LBS KG]	PAYLOAD [LBS KG]	CENTER COLUMN PLATE DIAMETER [INCHES MM]	MODEL	LENGTH [INCHES MM]	WIDE [INCHES MM]	HEIGHT [INCHES MM]	MAX LOAD [LBS KG]	WEIGHT [LBS KG]	SIZE RANGE [INCHES MM]
VEO MT-12	25.6 650	2.26 10.25	22.04 10.00	2.28 58	VEO CSM	-	0.97 247	11 279	-	0.05 0.25	
					VEO CSM DLX	-	1.22 31	2.24 57	-	0.19 0.815	
					VEO CSM2	4.72 120	1.75 44.5	2.0 50.8	4.4 2	0.41 1.85	
					VEO CSM3	3.44 87.4	0.87 22	1.14 29	4.4 2	0.19 0.86	
					VEO TCM	2.1					

MODEL	INTERIOR DIMENSIONS (INCHES MM)	EXTERIOR DIMENSIONS (INCHES MM)	MAX LOAD (LBS KG)	WEIGHT (LBS KG)	FITS DEVICE	LITER SIZE (L)
ALTA SKY 68	13.4 X 7.1 X 22.9 340 X 180 X 580	14.1 X 9 X 23.4 360 X 230 X 595	35.3 16.0	6.5 2.9	11" TABLET 16" LAPTOP	36
ALTA SKY 66	10.2 X 9.4 X 24 260 X 240 X 610	11.3 X 11.3 X 24.3 290 X 290 X 620	23.1 10.5	5.5 2.5	11" TABLET	30
ALTA SKY 53	12.6 X 7.8 X 20.8 320 X 200 X 530	15 X 10.6 X 22.8 380 X 270 X 580	35.2 16.0	8.2 2.8	17" LAPTOP	34
ALTA SKY 51D	12.6 X 7.8 X 20 320 X 200 X 510	14.6 X 10.2 X 22.2 370 X 260 X 565	29.7 13.5	6.4 2.9	15" LAPTOP	32
ALTA SKY 45D	10.2 X 7.5 X 17.7 260 X 190 X 450	12.2 X 9 X 19.5 310 X 230 X 495	19.8 9.0	4.8 2.2	13" LAPTOP	22
VED ACTIVE 53	12.2 X 7.1 X 20.9 310 X 180 X 530	12.9 X 9.8 X 21.7 330 X 250 X 550	44.1 20	6.52 2.96	10" TABLET 16" LAPTOP	45
VED ACTIVE 49	12.2 X 7.1 X 19.3 310 X 180 X 490	12.9 X 9.8 X 20.1 330 X 250 X 510	35.3 16	6.22 2.82	10" TABLET 15" LAPTOP	35
VED ACTIVE 46	10.6 X 6.3 X 18.1 270 X 160 X 460	11.4 X 9.1 X 18.7 290 X 230 X 475	24.2 11	5.60 2.54	10" TABLET 14" LAPTOP	25
VED ACTIVE 42M	9.8 X 5.9 X 17.7 250 X 150 X 420	10.6 X 7.5 X 17.3 270 X 190 X 440	18.7 8.5	4.32 1.96	10" TABLET 13" LAPTOP	17
VED SELECT 59T	13 X 6.8 X 18.5 330 X 170 X 470	14.2 X 8.7 X 21.5 360 X 220 X 545	33.1 15	9.22 4.18	11" TABLET 17" LAPTOP	26
VED SELECT 58T	11.8 X 6.9 X 18.5 300 X 175 X 470	14.2 X 10.2 X 24 360 X 260 X 610	33.1 15	11.24 5.10	11" TABLET 16" LAPTOP	26
VED SELECT 55BT	12.3 X 6.3 X 17.5 310 X 160 X 445	14.2 X 8.2 X 22.1 360 X 220 X 560	27.6 12.5	9.52 4.32	11" TABLET 15" LAPTOP	22
VED SELECT 42T	14.6 X 6.3 X 13 370 X 160 X 330	16.5 X 9.9 X 17.9 420 X 250 X 455	26.5 12	8.55 3.88	11" TABLET 15" LAPTOP	20
VED SELECT 48BF	11.8 X 6.5 X 18.9 300 X 165 X 480	13.3 X 9.6 X 20.5 335 X 245 X 520	25.57 11.6	4.28 1.94	11" TABLET 15" LAPTOP	24
VED SELECT 45BPM	10.6 X 5.1 X 16.9 270 X 130 X 430	11.8 X 8.3 X 18.3 300 X 210 X 465	19.18 8.7	3.26 1.48	11" TABLET	15
VED SELECT 46BR	9.9 X 5.9 X 18.1 250 X 150 X 460	11.0 X 8.3 X 18.7 280 X 210 X 475	19.8 9.0	3.04 1.38	13" LAPTOP	17
VED SELECT 37BRM	10.0 X 4.5 X 14.6 255 X 115 X 370	11.0 X 6.9 X 15.4 280 X 175 X 390	9.3 4.2	2.38 1.08	11" TABLET	11
VED SELECT 49	11.3 X 4.9 X 19.2 290 X 125 X 490	13.3 X 8.1 X 19.9 340 X 205 X 505	20.28 9.2	3.66 1.66	15" LAPTOP	18
VED SELECT 45M	10.9 X 4.4 X 17.7 275 X 110 X 450	12.6 X 7.5 X 18.1 320 X 190 X 460	17.19 7.8	3.33 1.51	15" LAPTOP	14
VED SELECT 41	10.9 X 4.9 X 16.1 275 X 125 X 410	12.6 X 8.1 X 16.5 320 X 205 X 420	11.9 5.4	3.37 1.53	13" LAPTOP	14
VED SELECT 43RB	9 X 4.9 X 16.5 230 X 125 X 420	12.3 X 8.1 X 18.5 310 X 205 X 470	16.5 7.5	2.76 1.25	11" TABLET	12
VED SELECT 39RBM	8.3 X 4 X 15 210 X 100 X 380	10.7 X 6.8 X 16.9 270 X 170 X 430	9.3 4.2	2.36 1.07	11" TABLET	8
VED SELECT 36S	14.6 X 6.9 X 9.0 370 X 175 X 230	15.8 X 9.9 X 11.4 400 X 250 X 290	24.2 11	3.70 1.68	13" LAPTOP	15
VED SELECT 28S	11.0 X 6.5 X 9.0 280 X 165 X 230	12.8 X 9.0 X 11.0 325 X 230 X 280	15.4 7	3.06 1.39	11" TABLET	10
VED SELECT 22S	9.3 X 4.8 X 7.3 235 X 120 X 185	10.6 X 6.8 X 9.0 270 X 170 X 230	6.6 3	1.68 0.76	7.9" TABLET	5
VED CITY CB 34	11.4-13 X 3.9 X 9.3 290-330 X 100 X 235	13.8 X 5.8 X 9.9 350 X 145 X 250	18.7 8.5	2.25 1.02	12.9" TABLET	8
VED CITY CB 29	10.3-11.4 X 3.5 X 7.9 260-290 X 90 X 200	12.3 X 5.4 X 8.5 310 X 135 X 215	11.0 5	1.81 0.82	8.3" TABLET	6
VED CITY CB 24	8.6-9.5 X 3.1 X 5.8 220-240 X 80 X 140	10.3 X 4.8 X 6.3 260 X 120 X 160	5.5 2.5	1.28 0.58	-	3
VED CITY TP 33	13.4 X 3.8 X 9.9 340 X 95 X 250	14.1 X 6.5 X 10.6 360 X 165 X 270	17.6 8	2.60 1.18	12.9" TABLET 13" LAPTOP	8
VED CITY TP 28	11 X 3.4 X 6.8 280 X 85 X 170	11.8 X 4.8 X 7.6 300 X 120 X 195	6.6 3	1.54 0.70	8.3" TABLET	4
VED CITY TP 23	9 X 3.4 X 5.5 230 X 85 X 140	9.9 X 4.8 X 6.3 250 X 120 X 160	4.4 2	1.23 0.56	-	2.5
VED RANGE T48	11.8 X 7.5 X 18.9 300 X 190 X 480	12.8 X 9.9 X 19.6 325 X 250 X 500	25.4 11.5	4.80 2.18	15.6" LAPTOP	27
VED RANGE T45M	11.0 X 5.1 X 17.8 280 X 130 X 450	11.8 X 7.5 X 18.5 300 X 190 X 470	22.0 10	4.14 1.88	13.4" LAPTOP	16
VED RANGE T37M	10.0 X 4.5 X 14.6 255 X 115 X 370	11.0 X 7.1 X 15.4 280 X 180 X 390	15.4 7.0	3.02 1.37	11" LAPTOP	11
VED RANGE 38	15.1 X 5.7 X 11.7 385 X 145 X 300	16.8 X 8.2 X 13.3 430 X 210 X 340	15.9 7.2	2.64 1.20	15" LAPTOP	17
VED RANGE 32M	12.6 X 5.3 X 9.1 320 X 135 X 230	14.2 X 6.5 X 9.8 360 X 165 X 250	12.1 5.5	1.85 0.84	12.9" TABLET	10
VED RANGE 21M	9.2 X 4.4 X 7.5 235 X 110 X 190	10.6 X 6.3 X 8.6 270 X 160 X 220	6.2 2.8	1.06 0.48	7.9" TABLET	5
VED ADAPTOR R48	10.3 X 6.3 X 18.0 260 X 160 X 480	11.4 X 8.6 X 19.3 290 X 220 X 490	25.4 11.5	3.22 1.46	16" MAC BOOK	20
VED ADAPTOR R44	8.6 X 6.3 X 16.9 220 X 160 X 430	10.3 X 8.6 X 17.8 260 X 220 X 450	19.8 9.0	2.78 1.26	13" MAC BOOK	16
VED ADAPTOR S46	9.5 X 6.3 X 17.8 240 X 160 X 450	10.6 X 8.8 X 18.3 270 X 220 X 465	18.7 8.5	3.02 1.37	15" MAC BOOK	18
VED ADAPTOR S41	7.9 X 5.9 X 16.1 200 X 150 X 410	9.5 X 8.3 X 16.5 240 X 210 X 420	11.5 5.2	2.53 1.15	10" IPAD	12
VED ADAPTOR 24M	8.9 X 4.5 X 6.3 225 X 115 X 160	9.8 X 5.9 X 9.1 250 X 150 X 230	25.4 11.5	0.97 0.44	8" TABLET	4.1
VED ADAPTOR 15M	7.1 X 4.1 X 5.9 180 X 105 X 150	8.3 X 5.3 X 8.7 210 X 135 X 220	19.8 9.0	0.71 0.32	-	2.8
VED GO 46M	10.4 X 4.1 X 18.1 265 X 105 X 460	11.4 X 5.5 X 18.5 290 X 140 X 470	15.9 7.2	2.20 1.00	13" LAPTOP	13
VED GO 42M	9.6 X 3.8 X 16.5 245 X 95 X 420	10.3 X 5.1 X 16.9 260 X 130 X 430	8.8 4.0	1.98 0.90	11" TABLET	9.8
VED GO 34M	13.4 X 4.1 X 9.0 340 X 105 X 230	14.0 X 5.1 X 9.9 355 X 130 X 250	11.5 5.2	1.54 0.70	11" TABLET	8.2
VED GO 24M	8.8 X 4.1 X 6.2 225 X 105 X 160	9.5 X 4.8 X 7.1 240 X 125 X 180	6.6 3.0	0.75 0.34	-	3.8
VED GO 21M	8.3 X 4.1 X 7.5 210 X 105 X 180	10.6 X 5.8 X 8.3 270 X 145 X 210	6.2 2.8	0.93 0.421	7.9" TABLET	4.2
VED GO 15M	7.1 X 4.1 X 6.2 180 X 105 X 160	7.6 X 4.8 X 7.1 195 X 125 X 180	3.3 1.5	0.68 0.31	-	3.0
VED BIB T25	9.8 X 4.3 X 7.5 250 X 110 X 190	10.8 X 5.5 X 8.3 275 X 140 X 210	7.1 3.2	1.15 0.52	-	5.2
VED BIB T22	8.7 X 3.9 X 6.3 220 X 100 X 160	9.8 X 5.1 X 7.3 250 X 130 X 185	6.2 2.8	0.88 0.40	-	3.5
VED BIB T18	7.1 X 3.9 X 5.5 180 X 100 X 140	8.3 X 5.1 X 6.7 210 X 130 X 170	4.4 2.0	0.71 0.32	-	2.5
VED BIB F36	11.0 X 6.3 X 15.0 280 X 160 X 380	12.6 X 7.7 X 16.1 320 X 195 X 410	16.5 7.5	2.29 1.04	11" TABLET	17
VED BIB F33	11.0 X 6.3 X 11.0 280 X 160 X 280	12.4 X 7.7 X 12.4 315 X 195 X 315	13.2 6	1.90 0.86	11" TABLET	13
VED BIB F28	11.0 X 6.3 X 7.1 280 X 160 X 180	12.4 X 7.7 X 9.3 315 X 195 X 235	9.9 4.5	1.50 0.68	7" TABLET	8
VED BIB F27	8.3 X 4.3 X 11.0 210 X 110 X 280	9.4 X 5.7 X 12.4 240 X 145 X 315	8.4 3.8	1.19 0.54	7" TABLET	6.5
VED BIB DIVIDER S53	21.1 X 6.9 X 15.7 535 X 175 X 400	22.0 X 8.7 X 17.1 560 X 220 X 435	29.8 13.5	6.70 3.04	15" LAPTOP	38
VED BIB DIVIDER S46	17.5 X 6.9 X 12.8 445 X 175 X 325	18.9 X 8.5 X 14.0 480 X 215 X 355	24.2 11.0	5.33 2.42	13" LAPTOP	26
VED BIB DIVIDER S40	15.6 X 5.9 X 9.6 395 X 150 X 245	17.1 X 7.5 X 10.8 435 X 190 X 275	19.2 8.7	3.92 1.78	11" TABLET	15
VED BIB DIVIDER S37	13.6 X 5.9 X 8.1 345 X 150 X 205	15.4 X 7.5 X 9.8 390 X 190 X 250	13.7 6.2	3.13 1.42	7" TABLET	11

MODEL	INTERIOR DIMENSIONS (INCHES MM)	EXTERIOR DIMENSIONS (INCHES MM)	MAX LOAD (LBS KG)	WEIGHT (LBS KG)	FITS DEVICE	LITER SIZE (L)
DIVIDER BAG 53	21 X 15.8 X 6.9 535 X 400 X 175	22 X 16.8 X 7.9 560 X 425 X 200	-	3.84 1.65	-	-
DIVIDER BAG 46	17.5 X 12.9 X 6.9 445 X 325 X 175	18.8 X 13.7 X 7.6 480 X 345 X 195	-	3.00 1.34	-	-
DIVIDER BAG 40	15.5 X 9.6 X 5.9 395 X 245 X 150	17 X 10.9 X 6.8 430 X 275 X 170	-	1.98 0.90	-	-
DIVIDER BAG 37	13.7 X 8.1 X 5.9 345 X 205 X 150	15 X 9.8 X 6.8 380 X 240 X 170	-	1.65 0.75	-	-
SUPREME 53F / SUPREME 53D	22 X 17.7 X 7.8 560 X 450 X 200	24.8 X 20.4 X 9.4 630 X 520 X 240	-	23 10.4	-	-
SUPREME 46F / SUPREME 46D	18.9 X 14.5 X 7.8 480 X 370 X 200	20.2 X 17.1 X 8.6 515 X 435 X 220	-	15 6.8	-	-
SUPREME 40F / SUPREME 40D	16.9 X 11.6 X 6.8 430 X 295 X 175	18.3 X 14.3 X 7.6 465 X 365 X 195	-	9.7 4.4	-	-
SUPREME 37F / SUPREME 37D	16.3 X 10.2 X 6.8 380 X 260 X 175	16.3 X 9.2 X 7.6 415 X 325 X 195	-	8.6 3.9	-	-
SUPREME 27F / SUPREME 27D	11 X 9.8 X 6.6 250 X 190 X 150	11 X 9.8 X 6.6 280 X 250 X 170	-	4.19 1.9	-	-
VESTA ASPIRE 41	8.9 X 5.9 X 16.1 225 X 150 X 410	10 X 8.7 X 18.3 255 X 220 X 465	11.0 5	1.70 0.77	9.7" TABLET	-
VESTA ASPIRE 25	10.2 X 6.7 X 8.3 260 X 170 X 210	11.4 X 8.1 X 10 290 X 205 X 255	9.9 4.5	1.06 0.48	9" TABLET	-
VESTA ASPIRE 21	8.7 X 5.3 X 7.7 220 X 135 X 195	9.8 X 6.5 X 8.7 250 X 165 X 220	5.1 2.3	0.73 0.33	-	-
VESTA ASPIRE 15	6.3 X 4.5 X 5.9 160 X 115 X 150	7.0 X 5.9 X 7.9 180 X 150 X 200	3.3 1.5	0.48 0.22	-	-
VESTA ASPIRE 15Z	5.9 X 4.9 X 7.9 150 X 125 X 200	6.9 X 5.7 X 9.4 175 X 145 X 240	4.9 2.2	0.51 0.23	-	-
ALTA ACTION 60	23.6 X 5.5 X 3.8 600 X 140 X 100	24.2 X 5.8 X 4.3 615 X 150 X 110	6.6 3	0.66 0.30	-	-
ALTA ACTION 70	27.5 X 6.7 X 5.1 700 X 170 X 130	28.1 X 7.1 X 5.5 715 X 180 X 140	7.7 3.5	0.77 0.35	-	-
ALTA ACTION 80	31.5 X 6.7 X 5.1 800 X 170 X 130	32.1 X 7.1 X 5.5 815 X 180 X 140	8.8 4.0	0.84 0.38	-	-

MODEL	POWER	OBJECTIVE LENS (MM)	FIELD OF VIEW (FT/1000 YDS M/1000 M)	NEAR FOCUS (FEET M)	EYE RELIEF (MM)	ADJUST. PUPILLARY (MM)	WEIGHT (OZ G)
ENDEAVOR HD 82A	20-60 X	82	110-52 37-17	19.7-21.3 6-6.5	19-20	-	63.85 1810
ENDEAVOR HD 65A	15-45 X	65	144-68 48-23	14.8-18 4.5-5.5	19-20	-	51.15 1450
ENDEAVOR XF 80A	20-60 X	80	110-52 37-17	19.7-21.3 6-6.5	19-20	-	59.3 1680
ENDEAVOR XF 60A	15-45 X	60	141-68 47-23	16.4-19.7 5-6	19-20	-	45.1 1280
VED HD 80A	20-60 X	80	110-52 37-17	19.7-21.3 6-6.5	19-20	-	54.7 1550
VED HD 60A	15-45 X	60	141-68 47-23	16.4-19.7 5-6	19-20	-	42.5 1205
VESTA 560A	15-45X	60	34.8 - 20.9 104.4 - 62.6	8 - 9 26.3 - 29.5	16-21	-	45.7 1293
VESTA 460A	15-50X	60	41.7 - 19.1 125.3 - 57.4	10 - 12 32.8 - 39.4	11	-	21.5 609
VESTA 350A	12-45X	50	52.2 - 17.4 156.6 - 52.2	9 - 12 29.5 - 39.4	11	-	21.2 600
VED HD IV 1042	10 X	42	340 114	5.9 1.8	19	56-74	27.7 786
VED HD IV 8420	8 X	42	377 126	5.9 1.8	19	56-74	27.7 786
VED HD2 1042	10 X	42	340 114	6.6 2.0	18	58-74	25 710
VED HD2 8420	8 X	42	377 126	6.6 2.0	19	58-74	25 710
VED HD 1042	10 X	42	342 114	6.6 2.0	18	58-74	27.1 767
VED HD 8420	8 X	42	372 124	6.6 2.0	19	58-74	26.8 760
VED ED 1250	12 X	50	251 84	11.5 3.5	18	60-75	26.8 760
VED ED 1250	10 X	50	282 94	9.8 3	19	59.5-75	27.6 782
VED ED 1042	10 X	42	314 105	9.2 2.8	16	55-75	22.6 640
VED ED 8420	8 X	42	330 110	8.2 2.5	19	55-75	22.6 640



WWW.VANGUARDWORLD.COM
